























































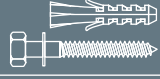





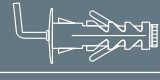





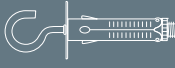























 Universal nylon anchors	<ul style="list-style-type: none"> <li> Cheilles universelles en nylon</li> <li> Universaldübel aus Nylon</li> <li> Tacos universales de nylon</li> <li> Универсальные нейлоновые дюбели</li> </ul>	<b>200</b>
	 Universal nylon anchors with screws	<ul style="list-style-type: none"> <li> Cheilles universelles en nylon avec vis</li> <li> Universaldübel aus Nylon mit Schrauben</li> <li> Tacos universales de nylon con tornillo</li> <li> Универсальные нейлоновые дюбели с шурупами</li> </ul>	<b>201</b>
	 PET Box with multi-purpose nylon anchor	<ul style="list-style-type: none"> <li> Boîte en plastique avec chevilles universelles</li> <li> Plastikdose mit Universal- Nylondübel</li> <li> Bote con tacos universales de nylon</li> <li> Коробочка с универсальными нейлоновыми дюбелями</li> </ul>	<b>204</b>
	 ClipBox with multi-purpose nylon anchor	<ul style="list-style-type: none"> <li> ClipBox avec chevilles universelles</li> <li> ClipBox mit Universal- Nylondübel</li> <li> Clipbox con tacos universales de nylon</li> <li> Clipbox с универсальными нейлоновыми дюбелями</li> </ul>	<b>206</b>
	 Nylon and Polypropylene anchors	<ul style="list-style-type: none"> <li> Cheilles universelles en nylon et en polypropylène</li> <li> Universaldübel aus Nylon und polypropylen</li> <li> Tacos universales de nylon y de polipropileno</li> <li> Нейлоновые и полипропиленовые дюбели</li> </ul>	<b>208</b>
	 Nylon anchors with screws	<ul style="list-style-type: none"> <li> Cheilles en nylon avec vis</li> <li> Nylondübel mit Schrauben</li> <li> Tacos de nylon con tornillo</li> <li> Нейлоновые дюбели с шурупами</li> </ul>	<b>211</b>
	 Nylon anchor Boxes	<ul style="list-style-type: none"> <li> Boîte de plastique avec chevilles en nylon</li> <li> Plastikverpackung mit Nylondübel</li> <li> Surtidos de tacos de nylon</li> <li> Наборы нейлоновых дюбелей</li> </ul>	<b>214</b>
	 Nylon anchors with accessories	<ul style="list-style-type: none"> <li> Cheville en nylon avec accessoires</li> <li> Nylondübel mit Zubehöre</li> <li> Tacos de nylon con accesorios</li> <li> Нейлоновые дюбели с аксессуарами</li> </ul>	<b>216</b>
	 Rimless anchor with hexagonal head wood screw	<ul style="list-style-type: none"> <li> Cheville sans collerette, avec vis à bois tête hexagonale</li> <li> Dübel ohne Saum mit Sechskant-Holzschraube</li> <li> Tacos sin collarín con tornillo para madera con cabeza hexagonal</li> <li> Дюбель без борта со специальным шурупом</li> </ul>	<b>217</b>
	 Nylon anchors with accessories	<ul style="list-style-type: none"> <li> Cheville en nylon avec vis spéciales</li> <li> Nylondübel mit besonderen Schrauben</li> <li> Tacos de nylon con accesorios</li> <li> Нейлоновые дюбели с шурупами</li> </ul>	<b>218</b>
	 Small steel anchor with accessories	<ul style="list-style-type: none"> <li> Petits cheville en Acier avec accessoires</li> <li> Kleine stahldübel mit Zubehöre</li> <li> Tacos de acero con accesorios</li> <li> Мелкие стальные дюбели с аксессуарами</li> </ul>	<b>220</b>
	 Zinc alloy hammer anchor with nail	<ul style="list-style-type: none"> <li> Cheville en alliage de zinc avec clou</li> <li> Nageldübel aus Zinklegierung</li> <li> Tacos de golpe de aleación de cinc montado con clavo</li> <li> Ударный дюбель с гвоздем из оцинкованного сплава</li> </ul>	<b>224</b>
	 Steel washers for insulated panels	<ul style="list-style-type: none"> <li> Rondelles acier pour la fixation de panneaux d'isolation</li> <li> Stahlscheiben für Befestigung von Isolierplatte</li> <li> Arandela de acero para paneles aislantes</li> <li> Стальные диски для изоляционных панелей</li> </ul>	<b>224</b>
	 Anchors for insulated panels	<ul style="list-style-type: none"> <li> Cheilles d'isolation</li> <li> Dübel für Befestigung von Isolierplatte</li> <li> Tacos de polipropileno para paneles aislantes</li> <li> Анкеры для изоляционных панелей</li> </ul>	<b>225</b>
	 Stop & Go - Magnetic door stop	<ul style="list-style-type: none"> <li> Stop&amp;Go - Ferme-porte magnetique</li> <li> Stop&amp;Go - Magnetischer Türschließer</li> <li> Stop&amp;Go - Tope de puertas magnético</li> <li> Stop &amp; Go - магнитный ограничитель открывания двери</li> </ul>	<b>226</b>





## Light fixing systems

-  Systèmes pour fixation légères
-  Systeme für leichte Befestigungen
-  Sistemas para fijaciones ligeras
-  Крепеж для легких конструкций

# JC - VZ <sup>New</sup>



## Multi-purpose (Patented) nylon anchor

-  Cheville Universelle en nylon (brevetée)
-  Universal- Nylondübel (patentiert)
-  Taco universal (Patentado) de nylon
-  Универсальный нейлоновый дюбель (запатентованный)

**JC 01 - VZ 01** Small box packing / petite boîte / kleine Verpackung / en caja / в коробке

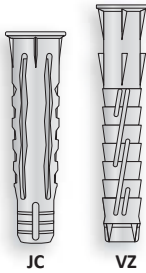

Item code	Anchor Size Ø x La (mm)	Pcs. per box	Pcs. per carton
JC 01 05 025	5 x 25	200	10.000
<i>New Item</i> VZ 01 06 032	6 x 32	200	10.000
<i>New Item</i> VZ 01 06 045	6 x 45	100	5.000
<i>New Item</i> VZ 01 08 042	8 x 42	100	5.000
<i>New Item</i> VZ 01 08 052	8 x 52	50	2.500
JC 01 10 050	10 x 50	50	2.500
JC 01 12 060	12 x 60	25	1.250
JC 01 14 070	14 x 70	25	750

Box / Boîte / Verpackung / Caja / Упаковка



**VZ 30** in bag / dans sachet / im Beutel / en bolsa / в пакете



Item code	Anchor Size Ø x La (mm)	Pcs. per bag	Pcs. per carton
<i>New Item</i> VZ 30 06 032	6 x 32	1.000	10.000
<i>New Item</i> VZ 30 06 045	6 x 45	1.000	10.000
<i>New Item</i> VZ 30 08 042	8 x 42	1.000	5.000
<i>New Item</i> VZ 30 08 052	8 x 52	500	5.000

Box / Boîte / Verpackung / Caja / Упаковка



**JC 00 - VZ 00** Bulk packing / emballage vrac / lose Verpackung / a granel / в индустриальной упаковке

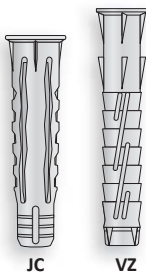

Item code	Anchor Size Ø x La (mm)	Pcs. per carton
JC 00 05 025	5 x 25	30.000
<i>New Item</i> VZ 00 06 032	6 x 32	15.000
<i>New Item</i> VZ 00 06 045	6 x 45	10.000
<i>New Item</i> VZ 00 08 042	8 x 42	5.000
<i>New Item</i> VZ 00 08 052	8 x 52	5.000
JC 00 10 050	10 x 50	2.500
JC 00 12 060	12 x 60	1.500
JC 00 14 070	14 x 70	1.000

Box / Boîte / Verpackung / Caja / Упаковка



# JC - VZ <sup>New</sup>

-  **Multi-purpose (Patented) nylon anchor with zinc plated flat CSK head chipboard screw**
-  Cheville Universelle en nylon (brevetée), avec vis tête fraisée plate pour panneaux de particules
-  Universal- Nyldübel (patentiert), mit Senkkopf- Spanplattenschraube
-  Taco universal (Patentado) de nylon con tornillo cabeza avellanada para aglomerado
-  Универсальный нейлоновый дюбель (запатентованный) в комплекте с оцинкованным шурупом с плоской потайной головкой

**JC 02 - VZ 02** Small box packing / petite boîte / kleine Verpackung / en caja / в коробке

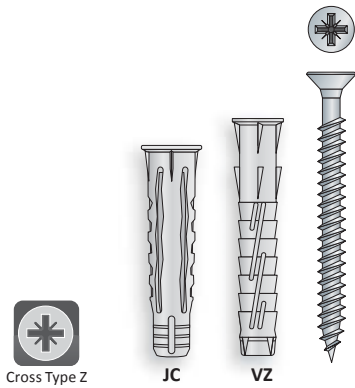

Item code	Anchor Size Ø x La (mm)	Screw Size Ø x Ls (mm)	Pcs. per box	Pcs. per carton
JC 02 05 025	5 x 25	3,5 x 30	200	10.000
<i>New Item</i> VZ 02 06 032	6 x 32	4,5 x 45	100	5.000
<i>New Item</i> VZ 02 06 045	6 x 45	4,5 x 55	100	3.000
<i>New Item</i> VZ 02 08 042	8 x 42	5 x 50	50	2.500
<i>New Item</i> VZ 02 08 052	8 x 52	5 x 60	50	1.500
JC 02 10 050	10 x 50	6 x 60	25	1.250

CuboBox / ExpoBox



Available in SPECIAL OFFER (VZ type only) in "ExpoBox" (see "T-Store - Merchandising" section).

Box / Boîte / Verpackung / Caja / Упаковка



Minimum Order Quantity: 1 carton

**JC 03 - VZ 03** 10 sets bag packing / sachets de 10 pcs / 10 St. im Beutel / 10 unidades en cada bolsa / в мешочке по 10 шт

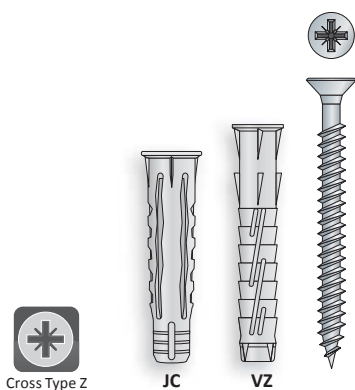

Item code	Anchor Size Ø x La (mm)	Screw Size Ø x Ls (mm)	Pcs. per bag	Bags per carton
JC 03 05 025	5 x 25	3,5 x 30	10	100
<i>New Item</i> VZ 03 06 032	6 x 32	4,5 x 45	10	100
<i>New Item</i> VZ 03 06 045	6 x 45	4,5 x 55	10	100
<i>New Item</i> VZ 03 08 042	8 x 42	5 x 50	10	50
<i>New Item</i> VZ 03 08 052	8 x 52	5 x 60	10	25
JC 03 10 050	10 x 50	6 x 60	10	25

Box / Boîte / Verpackung / Caja / Упаковка



# JC - VZ <sup>New</sup>



- Multi-purpose (Patented) nylon anchor with zinc plated pan washer head chipboard screw, small box packing**
- Cheville Universelle en nylon (brevetée), avec vis tête cylindrique pour panneaux de particules, petite boîte
- Universal- Nylandübel (patentiert), mit Rundkopf- Spanplattenschraube, kleine Verpackung
- Taco universal de nylon (patentado) con tornillo cabeza cilíndrica arandela estampada para aglomerado, en caja
- Универсальный нейлоновый дюбель (запатентованный) в комплекте с оцинкованным шурупом с полукруглой головкой с пресс-шайбой, в коробке

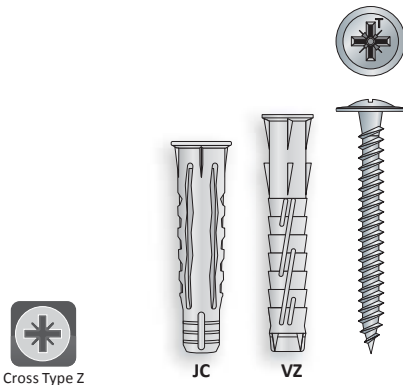

Item code	Anchor Size Ø x La (mm)	Screw Size Ø x Ls (mm)	Pcs. per box	Pcs. per carton
JC 04 05 025	5 x 25	3,5 x 30	100	1.000
<i>New Item</i> VZ 04 06 032	6 x 32	4,5 x 45	100	3.000
<i>New Item</i> VZ 04 06 045	6 x 45	4,5 x 55	100	3.000
<i>New Item</i> VZ 04 08 042	8 x 42	5 x 50	50	1.500
<i>New Item</i> VZ 04 08 052	8 x 52	5 x 60	50	1.500
JC 04 10 050	10 x 50	6 x 60	25	250

Box / Boîte / Verpackung / Caja / Упаковка



# JC - VZ <sup>New</sup>



- Multi-purpose (Patented) nylon anchor with A2 (AISI 304) stainless steel flat CSK head chipboard screw, small box packing**
- Cheville Universelle en nylon (brevetée), avec vis tête fraisée plate pour panneaux de particules en acier inox A2 (AISI 304), petite boîte
- Universal- Nylandübel (patentiert), mit Edelstahl A2 (AISI 304) Senkkopf- Spanplattenschraube, kleine Verpackung
- Taco universal de nylon (patentado) con tornillo de acero inoxidable A2 (AISI 304) cabeza avellanada para aglomerado, en caja
- Универсальный нейлоновый дюбель (запатентованный) в комплекте с шурупом из нержавеющей стали A2 (AISI 304) с плоской потайной головкой, в коробке

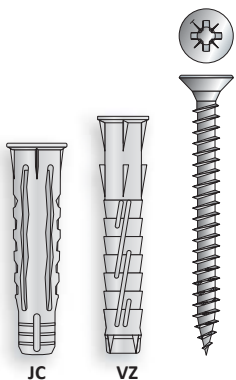

Item code	Anchor Size Ø x La (mm)	Screw Size Ø x Ls (mm)	Pcs. per box	Pcs. per carton
JC 05 05 025	5 x 25	3,5 x 30	200	2.000
<i>New Item</i> VZ 05 06 032	6 x 32	4,5 x 45	100	1.000
<i>New Item</i> VZ 05 06 045	6 x 45	4,5 x 60	100	1.000
<i>New Item</i> VZ 05 08 042	8 x 42	5 x 50	50	500
<i>New Item</i> VZ 05 08 052	8 x 52	5 x 60	50	500
JC 05 10 050	10 x 50	6 x 60	25	250

Box / Boîte / Verpackung / Caja / Упаковка



# JC 06

 **Multi-purpose rimmed nylon anchor with zinc plated hex head wood screw, small box packing**

 Cheville Universelle avec collerette, avec vis à bois tête hexagonale, petite boîte

 Universaldübel mit Saum mit Senkkopf- Holzschraube, kleine Verpackung

 Taco universal de nylon con collarín con tornillo cabeza hexagonal para madera, en caja

 Универсальный нейлоновый дюбель с бортом в комплекте с оцинкованным шурупом с шестигранной головкой, в коробке

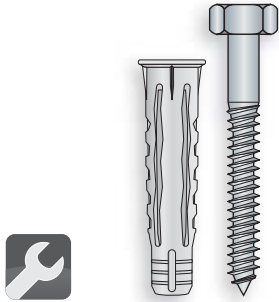







Item code	Anchor Size	Screw Size	Pcs. per box	Pcs. per carton
	Ø x La (mm)	Ø x Ls (mm)		
JC 06 10 050	10 x 50	6 x 60	50	500
JC 06 12 060	12 x 60	8 x 70	50	500
JC 06 14 070	14 x 70	10 x 80	50	500

Box / Boîte / Verpackung / Caja / Упаковка



## JC-VZ Nylon anchor setting details

Plug diameter	Plasterboard	Hollow masonry	Hollow masonry with plaster	Solid masonry	Tuff	Aerated autoclaved concrete	Concrete
JC Ø 5 x 25							
JC Ø 5 x 25	✓	✓	✓	✓	NPD	NPD	✓
VZ Ø 6 x 32	✓	✓	✓	✓	✓	✓	✓
VZ Ø 6 x 45	✓	✓	✓	✓	✓	✓	✓
VZ Ø 8 x 42	✓	✓	✓	✓	✓	✓	✓
VZ Ø 8 x 52	✓	✓	✓	✓	✓	✓	✓
JC Ø 10 x 50	Only suitable for in-place anchorages of 10mm min. thickness hard fixture	✓	✓	✓	NPD	NPD	✓
JC Ø 12	Only suitable for in-place anchorages of 10mm min. thickness hard fixture	Only suitable for in-place anchorages of 10mm min. thickness hard fixture	✓	✓	NPD	NPD	✓
JC Ø 14	Only suitable for in-place anchorages of 10mm min. thickness hard fixture	Only suitable for in-place anchorages of 10mm min. thickness hard fixture	✓	✓	NPD	NPD	✓

NPD: Performance unreported

# VZB 02 <sup>New</sup>



- PET Box with VZ-Handyplug® multi-purpose (Patented) nylon anchor with zinc plated flat CSK head chipboard screw, one professional drill and one bit**
- Boîte en plastique avec chevilles universelles VZ-Handyplug® (BREVETE) en nylon et vis tête fraisée plate pour panneaux de particules, un foret professionnel et un embout de vissage**
- Plastikdose mit Universal-Nylondübel VZ-Handyplug® (PATENTIERT) und Senkkopf-Spanplattenschrauben, ein professioneller Bohrer und ein Bit**
- Bote con tacos universales de nylon VZ-Handyplug® (PATENTADOS), con tornillos cabeza avellanada para aglomerado, una broca profesional y una punta de atornillar**
- Коробочка с универсальными нейлоновыми дюбелями VZ-Handyplug® (запатентованные) в комплекте с шурупами с плоской потайной головкой, в комплекте с одним буром и одним битом**

## Ø 6 mm

Minimum Order Quantity: 1 carton



Item code	Anchor Size	Screw Size	Pcs. per box Anchors + Screws	Box per Carton
	Ø x La (mm)	Ø x Ls (mm)		
VZB 02 06 032	6 x 32	4,5 x 45	250 + 250	12
VZB 02 06 045	6 x 45	4,5 x 55	200 + 200	12

### Contents

**VZB 02 06 032:** 250 anchors (Ø 6 x 32) + 250 screws (Ø 4,5 x 45) + 1 drill bit + 1 bit = **502 pz.**  
**VZB 02 06 045:** 200 anchors (Ø 6 x 45) + 200 screws (Ø 4,5 x 55) + 1 drill bit + 1 bit = **402 pz.**

## Ø 8 mm

Minimum Order Quantity: 1 carton



Item code	Anchor Size	Screw Size	Pcs. per box Anchors + Screws	Box per Carton
	Ø x La (mm)	Ø x Ls (mm)		
VZB 02 08 042	8 x 42	5 x 50	150 + 150	12
VZB 02 08 052	8 x 52	5 x 60	125 + 125	12

### Contents

**VZB 02 08 042:** 150 anchors (Ø 8 x 42) + 150 screws (Ø 5 x 50) + 1 drill bit + 1 bit = **302 pz.**  
**VZB 02 08 052:** 125 anchors (Ø 8 x 52) + 125 screws (Ø 5 x 60) + 1 drill bit + 1 bit = **252 pz.**

### Box / Boîte / Verpackung / Caja / Упаковка







Carton with 12 PET Boxes.  
Minimum Order Quantity: 1 carton



# VZCB <sup>New</sup>



-  **“CuboBox” display stand with 8 PET boxes with VZ-Handyplug® multi-purpose (Patented) nylon anchor with zinc plated flat CSK head chipboard screw**
-  Assortiment “CuboBox” de 8 boîtes en plastique avec chevilles universelles VZ-Handyplug® et vis tête fraisée plate pour panneaux de particules
-  Sortiment “CuboBox” mit 8 Plastikdosen von VZ-Handyplug® Universal- Nylondübel mit Senkkopf- Spanplattenschrauben
-  Kit “CuboBox” con 8 botes de tacos universales de nylon VZ-Handyplug®, con tornillos cabeza avellanada para aglomerado
-  Настольный дисплей “CuboBox” с 8 коробочками универсальных нейлоновых дюбелей VZ-Handyplug® в комплекте с шурупами с плоской потайной головкой

## Ø 6 mm

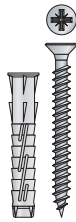



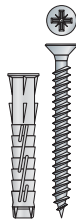

Item code	Contents	Anchor Size	Screw Size
		Ø x La (mm)	Ø x Ls (mm)
VZCB 02 06 032	VZB 02 06 032 - 8 PET boxes	6 x 32	4,5 x 45
VZCB 02 06 045	VZB 02 06 045 - 8 PET boxes	6 x 45	4,5 x 55

## Ø 8 mm



Item code	Contents	Anchor Size	Screw Size
		Ø x La (mm)	Ø x Ls (mm)
VZCB 02 08 042	VZB 02 08 042 - 8 PET boxes	8 x 42	5 x 50
VZCB 02 08 052	VZB 02 08 052 - 8 PET boxes	8 x 52	5 x 60

# KIT VZB

-  **“ExpoBox” display stand with 16 PET boxes with multi-purpose (Patented) nylon anchor with zinc plated flat CSK head chipboard screw**
-  Assortiment “ExpoBox” de 16 boîtes en plastique avec chevilles universelles VZ-Handyplug® et vis tête fraisée plate pour panneaux de particules
-  Sortiment “ExpoBox” mit 16 Plastikdosen von VZ-Handyplug® Universal- Nylondübel mit Senkkopf- Spanplattenschrauben
-  Kit “ExpoBox” con 16 botes de tacos universales de nylon VZ-Handyplug®, con tornillos cabeza avellanada para aglomerado
-  “ExpoBox” с 16 коробочками универсальных нейлоновых дюбелей VZ-Handyplug® в комплекте с шурупами с плоской потайной головкой

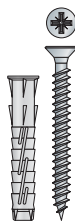

Item code	Contents	Anchor Size	Screw Size
		Ø x La (mm)	Ø x Ls (mm)
KIT VZB 02 001	VZB 02 06 032 - 4 PET boxes	6 x 32	4,5 x 45
	VZB 02 06 045 - 4 PET boxes	6 x 45	4,5 x 55
	VZB 02 08 042 - 4 PET boxes	8 x 42	5 x 50
	VZB 02 08 052 - 4 PET boxes	8 x 52	5 x 60
KIT VZB 02 002	VZB 02 06 032 - 8 PET boxes	6 x 32	4,5 x 45
	VZB 02 08 042 - 8 PET boxes	8 x 42	5 x 50
KIT VZB 02 003	VZB 02 06 045 - 8 PET boxes	6 x 45	4,5 x 55
	VZB 02 08 052 - 8 PET boxes	8 x 52	5 x 60

# VZX <sup>New</sup>

Minimum Order Quantity: 1 carton



- ClipBox with VZ-Handyplug® multi-purpose (Patented) nylon anchor with zinc plated flat CSK head chipboard screw**
- ClipBox avec chevilles universelles VZ-Handyplug® (BREVETE) en nylon et vis tête fraisée plate pour panneaux de particules**
- ClipBox mit Universal- Nyldübel VZ-Handyplug® (PATENTIERT) und Senkkopf- Spanplattenschrauben**
- Clipbox con tacos universales de nylon VZ-Handyplug® (PATENTADOS), con tornillos cabeza avellanada para aglomerado**
- Clipbox (с зажимом) с универсальными нейлоновыми дюбелями VZ-Handyplug® в комплекте с шурупами с плоской потайной головкой**



Item code	Anchor Size Ø x La (mm)	Screw Size Ø x Ls (mm)	Colour / RAL	Pcs. per Clipbox Anchors + Screws	Clipbox per Carton
<b>Anchor size: Ø 8 x 52 mm</b>					
VZX 01 06 032	6 x 32	4,5 x 45	Black / RAL 9005	50 + 50	24
VZX 02 06 032	6 x 32	4,5 x 45	Red / RAL 3020	50 + 50	24
VZX 04 06 032	6 x 32	4,5 x 45	Yellow / RAL 1021	50 + 50	24
VZX 05 06 032	6 x 32	4,5 x 45	Green / RAL 6035	50 + 50	24
VZX 06 06 032	6 x 32	4,5 x 45	Blue / RAL 5017	50 + 50	24
VZX 07 06 032	6 x 32	4,5 x 45	White	50 + 50	24
VZX 08 06 032	6 x 32	4,5 x 45	Pink / RAL 4003	50 + 50	24
VZX 09 06 032	6 x 32	4,5 x 45	Violet / RAL 4008	50 + 50	24
VZX 10 06 032	6 x 32	4,5 x 45	Purple Red / RAL 3004	50 + 50	24
<b>Anchor size: Ø 6 x 45 mm</b>					
VZX 01 06 045	6 x 45	4,5 x 55	Black / RAL 9005	40 + 40	24
VZX 02 06 045	6 x 45	4,5 x 55	Red / RAL 3020	40 + 40	24
VZX 04 06 045	6 x 45	4,5 x 55	Yellow / RAL 1021	40 + 40	24
VZX 05 06 045	6 x 45	4,5 x 55	Green / RAL 6035	40 + 40	24
VZX 06 06 045	6 x 45	4,5 x 55	Blue / RAL 5017	40 + 40	24
VZX 07 06 045	6 x 45	4,5 x 55	White	40 + 40	24
VZX 08 06 045	6 x 45	4,5 x 55	Pink / RAL 4003	40 + 40	24
VZX 09 06 045	6 x 45	4,5 x 55	Violet / RAL 4008	40 + 40	24
VZX 10 06 045	6 x 45	4,5 x 55	Purple Red / RAL 3004	40 + 40	24
<b>Anchor size: Ø 8 x 42 mm</b>					
VZX 01 08 042	8 x 42	5 x 50	Black / RAL 9005	30 + 30	24
VZX 02 08 042	8 x 42	5 x 50	Red / RAL 3020	30 + 30	24
VZX 04 08 042	8 x 42	5 x 50	Yellow / RAL 1021	30 + 30	24
VZX 05 08 042	8 x 42	5 x 50	Green / RAL 6035	30 + 30	24
VZX 06 08 042	8 x 42	5 x 50	Blue / RAL 5017	30 + 30	24
VZX 07 08 042	8 x 42	5 x 50	White	30 + 30	24
VZX 08 08 042	8 x 42	5 x 50	Pink / RAL 4003	30 + 30	24
VZX 09 08 042	8 x 42	5 x 50	Violet / RAL 4008	30 + 30	24
VZX 10 08 042	8 x 42	5 x 50	Purple Red / RAL 3004	30 + 30	24
<b>Anchor size: Ø 8 x 52 mm</b>					
VZX 01 08 052	8 x 52	5 x 60	Black / RAL 9005	25 + 25	24
VZX 02 08 052	8 x 52	5 x 60	Red / RAL 3020	25 + 25	24
VZX 04 08 052	8 x 52	5 x 60	Yellow / RAL 1021	25 + 25	24
VZX 05 08 052	8 x 52	5 x 60	Green / RAL 6035	25 + 25	24
VZX 06 08 052	8 x 52	5 x 60	Blue / RAL 5017	25 + 25	24
VZX 07 08 052	8 x 52	5 x 60	White	25 + 25	24
VZX 08 08 052	8 x 52	5 x 60	Pink / RAL 4003	25 + 25	24
VZX 09 08 052	8 x 52	5 x 60	Violet / RAL 4008	25 + 25	24
VZX 10 08 052	8 x 52	5 x 60	Purple Red / RAL 3004	25 + 25	24



**Black**  
RAL 9005

**Red**  
RAL 3020

**Yellow**  
RAL 1021

**Green**  
RAL 6035

**Blue**  
RAL 5017

**White**

**Pink**  
RAL 4003

**Violet**  
RAL 4008

**Purple Red**  
RAL 3004

Box / Boîte / Verpackung / Caja / Упаковка



Carton with 24 ClipBox.  
Minimum Order Quantity: 1 carton



# VZXC <sup>New</sup>



- Display stand with 16 ClipBox with VZ-Handyplug® multi-purpose (Patented) nylon anchor with zinc plated flat CSK head chipboard screw
- Assortiment de 16 ClipBox en plastique avec chevilles universelles VZ-Handyplug® et vis tête fraisée plate pour panneaux de particules
- Sortiment mit 16 ClipBox von VZ-Handyplug® Universal- Nylondübel mit Senkkopf- Spanplattenschrauben
- Kit con 16 Clipbox de tacos universales de nylon VZ-Handyplug®, con tornillos cabeza avellanada para aglomerado
- Настольный дисплей с 16 "ClipBox" с универсальными нейлоновыми дюбелями VZ-Handyplug® в комплекте с шурупами с плоской потайной головкой

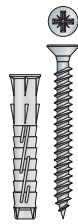

Item code	Contents	Pcs. per Clipbox Anchors + Screws	Anchor Size Ø x La (mm)	Screw Size Ø x Ls (mm)
Anchor size: Ø 6 mm				
VZXC xx* 06 032	16 clipbox	50 + 50	6 x 32	4,5 x 45
VZXC xx* 06 045	16 clipbox	40 + 40	6 x 45	4,5 x 55
Anchor size: Ø 8 mm				
VZXC xx* 08 042	16 clipbox	30 + 30	8 x 42	5 x 50
VZXC xx* 08 052	16 clipbox	25 + 25	8 x 52	5 x 60



*XX	Contents	Colours	
51	16 clipbox	Blue	
52	8 clipbox 8 clipbox	White Black	
53	8 clipbox 8 clipbox	Red Black	
54	8 clipbox 8 clipbox	Blue Black	
55	8 clipbox 8 clipbox	White Blue	
56	8 clipbox 8 clipbox	Yellow Red	
57	16 clipbox	Violet	
58	8 clipbox 8 clipbox	Red Blue	
59	8 clipbox 8 clipbox	Yellow Blue	
60	16 clipbox	Purple Red	
61	8 clipbox 8 clipbox	Pink Black	
62	8 clipbox 8 clipbox	Green Black	
63	8 clipbox 8 clipbox	White Red	
64	16 clipbox	Yellow	
99	16 clipbox	Assorted Colours	

# AX

## Rimmed nylon wall plug

 Cheville en nylon avec collerette

 Nylandübel mit Saum

 Taco de nylon con collarín

 Нейлоновый дюбель с бортом

### **AX 01** Small box packing / petite boîte / kleine Verpackung / en caja / в коробке

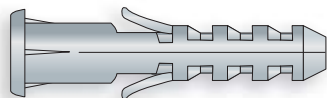

Item code	Anchor Size $\varnothing \times La$ (mm)	Pcs. per box	Pcs. per carton
<b>AX 01 05 025</b>	5 x 25	200	10.000
<b>AX 01 06 030</b>	6 x 30	100	5.000
<b>AX 01 08 040</b>	8 x 40	100	5.000
<b>AX 01 10 050</b>	10 x 50	50	2.500

Box / Boîte / Verpackung / Caja / Упаковка



### **AX30** 1.000 pcs. box / boîte à 1000 pcs. / Verpackung von 1000 St. / en caja de 1.000 unidades / В упаковке по 1000 шт

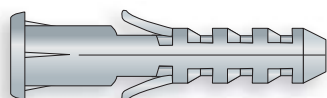

Item code	Anchor Size $\varnothing \times La$ (mm)	Pcs. per box	Pcs. per carton
<b>AX 30 05 025</b>	5 x 25	1.000	10.000
<b>AX 30 06 030</b>	6 x 30	1.000	10.000
<b>AX 30 08 040</b>	8 x 40	1.000	-
<b>AX 30 10 050</b>	10 x 50	1.000	-

Box / Boîte / Verpackung / Caja / Упаковка



### **AX06** Bulk packing / emballage vrac / lose Verpackung / a granel / в индустриальной упаковке

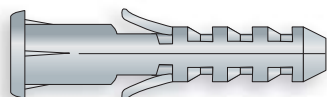





Item code	Anchor Size $\varnothing \times La$ (mm)	Pcs. per carton
<b>AX 06 05 025</b>	5 x 25	15.000
<b>AX 06 06 030</b>	6 x 30	10.000
<b>AX 06 08 040</b>	8 x 40	5.000
<b>AX 06 10 050</b>	10 x 50	2.500

Box / Boîte / Verpackung / Caja / Упаковка



# AX

-  **Rimless nylon wall plug**
-  Cheville en nylon sans collerette
-  Nylandübel ohne Saum
-  Taco de nylon sin collarín
-  Нейлоновый дюбель без борта

## AX 02 Small box packing / petite boîte / kleine Verpackung / en caja / в коробке

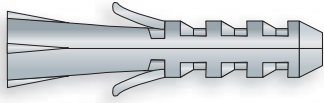

Box / Boîte / Verpackung / Caja / Упаковка



Item code	Anchor Size $\varnothing \times La$ (mm)	Pcs. per box	Pcs. per carton
AX 02 04 020	4 x 20	200	10.000
AX 02 05 025	5 x 25	200	10.000
AX 02 06 030	6 x 30	100	5.000
AX 02 07 030	7 x 30	100	5.000
AX 02 08 040	8 x 40	100	5.000
AX 02 10 050	10 x 50	50	2.500
AX 02 12 060	12 x 60	25	1.250
AX 02 14 080	14 x 75	25	250
AX 02 14 100	14 x 100	25	250
AX 02 16 080	16 x 80	20	200

## AX31 1.000 pcs. box / boîte à 1000 pcs. / Verpackung von 1000 St. / en caja de 1.000 unidades / В упаковке по 1000 шт

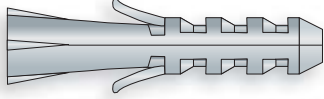

Box / Boîte / Verpackung / Caja / Упаковка



Item code	Anchor Size $\varnothing \times La$ (mm)	Pcs. per box	Pcs. per carton
AX 31 04 020	4 x 20	1.000	10.000
AX 31 05 025	5 x 25	1.000	10.000
AX 31 06 030	6 x 30	1.000	10.000
AX 31 07 030	7 x 30	1.000	-
AX 31 08 040	8 x 40	1.000	-
AX 31 10 050	10 x 50	1.000	-
AX 31 12 060	12 x 60	1.000	-

## AX07 Bulk packing / emballage vrac / lose Verpackung / a granel / в индустриальной упаковке

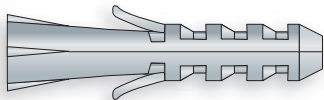

Box / Boîte / Verpackung / Caja / Упаковка



Item code	Anchor Size $\varnothing \times La$ (mm)	Pcs. per carton
AX 07 04 020	4 x 20	30.000
AX 07 05 025	5 x 25	15.000
AX 07 06 030	6 x 30	10.000
AX 07 07 030	7 x 30	10.000
AX 07 08 040	8 x 40	5.000
AX 07 10 050	10 x 50	2.500
AX 07 12 060	12 x 60	2.000
AX 07 14 080	14 x 75	500
AX 07 14 100	14 x 100	500
AX 07 16 080	16 x 80	500

# AX

## Rimmed PP wall plug

 Cheville en PP avec collerette

 PP Dübel mit Saum

 Taco de polipropileno con collarín

 Полипропиленовый дюбель с бортом

### **AX 03** Small box packing / petite boîte / kleine Verpackung / en caja / в коробке

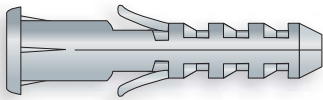

Item code	Anchor Size $\varnothing \times L_a$ (mm)	Pcs. per box	Pcs. per carton
<b>AX 03 06 030</b>	6 x 30	100	5.000
<b>AX 03 08 040</b>	8 x 40	100	5.000

Box / Boîte / Verpackung / Caja / Упаковка



### **AX 08** Bulk packing / emballage vrac / lose Verpackung / a granel / в индустриальной упаковке

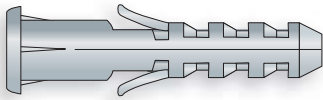





Item code	Anchor Size $\varnothing \times L_a$ (mm)	Pcs. per carton
<b>AX 08 06 030</b>	6 x 30	10.000
<b>AX 08 08 040</b>	8 x 40	5.000

Box / Boîte / Verpackung / Caja / Упаковка



# AX

-  **Rimless PP wall plug**
-  Cheville en PP sans collerette
-  PP Dübel ohne Saum
-  Taco de polipropileno sín collarín
-  Нейлоновый дюбель с бортом

**AX 04** Small box packing / petite boîte / kleine Verpackung / en caja / в коробке

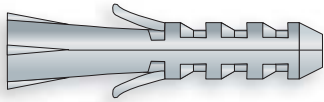

<i>Item code</i>	<i>Anchor Size</i> <i>∅ x La (mm)</i>	<i>Pcs. per box</i>	<i>Pcs. per carton</i>
<b>AX 04 14 080</b>	14 x 75	25	250

Box / Boîte / Verpackung / Caja / Упаковка



**AX 09** Bulk packing / emballage vrac / lose Verpackung / a granel / в индустриальной упаковке

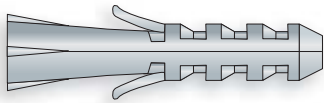

<i>Item code</i>	<i>Anchor Size</i> <i>∅ x La (mm)</i>	<i>Pcs. per carton</i>
<b>AX 09 14 080</b>	14 x 75	1.000

Box / Boîte / Verpackung / Caja / Упаковка





# AX

## 🇬🇧 Rimmed nylon wall plug with Flat CSK head chipboard screw

- 🇫🇷 Cheville en nylon avec collerette, avec vis tête fraisée plate pour panneaux de particules
- 🇩🇪 Nyfondübel mit Saum mit Spanplatten- Senkkopfschraube
- 🇪🇸 Taco de nylon con collarín con tornillo cabeza avellanada para aglomerado
- 🇷🇺 Нейлоновый дюбель с бортом в комплекте с шурупом с плоской потайной головкой

### AX 05 Small box packing / petite boîte / kleine Verpackung / en caja / в коробке

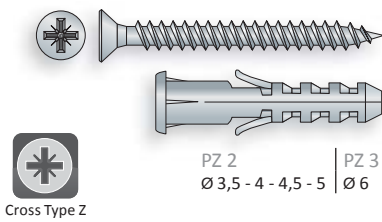

Item code	Anchor Size Ø x La (mm)	Screw Size Ø x Ls (mm)	Pcs. per box	Pcs. per carton
AX 05 05 025	5 x 25	3,5 x 30	200	10.000
AX 05 06 030	6 x 30	4 x 40	100	5.000
AX 28 06 030	6 x 30	4,5 x 40	100	5.000
AX 05 08 040	8 x 40	5 x 50	50	2.500
AX 05 10 050	10 x 50	6 x 60	25	1.250

#### Usage / Utilisation / Benutzung / Uso / Применение

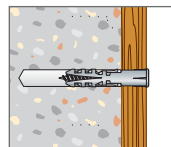

#### Box / Boîte / Verpackung / Caja / Упаковка



#### Set box and EasyBox



Available in set box (Item code: SE02 - pag. 206), and in "EasyBox" display unit (see "T-Store - Merchandising" section).

Minimum Order Quantity: 1 carton

### AX 12 10 sets bag packing / sachets de 10 pcs / 10 St. im Beutel / 10 unidades en cada bolsa / в мешочке по 10 шт

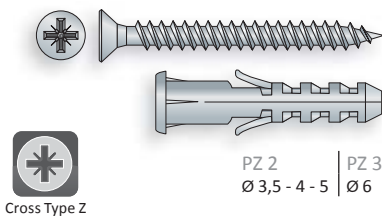

Item code	Anchor Size Ø x La (mm)	Screw Size Ø x Ls (mm)	Pcs. per bag	Pcs. per carton
AX 12 05 025	5 x 25	3,5 x 30	10	100
AX 12 06 030	6 x 30	4 x 40	10	100
AX 12 08 040	8 x 40	5 x 50	10	50
AX 12 10 050	10 x 50	6 x 60	10	25

#### Usage / Utilisation / Benutzung / Uso / Применение

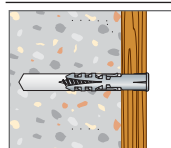





#### Box / Boîte / Verpackung / Caja / Упаковка



# AX

## Rimless nylon wall plug with Flat CSK head chipboard screw

-  Cheville en nylon sans collerette, avec vis tête fraisée plate pour panneaux de particules
-  Nylandübel ohne Saum mit Spanplatten- Senkkopfschraube
-  Taco de nylon sin collarín con tornillo cabeza avellanada para aglomerado
-  Нейлоновый дюбель без борта в комплекте с шурупом с плоской потайной головкой

### **AX 10** Small box packing / petite boîte / kleine Verpackung / en caja / в коробке

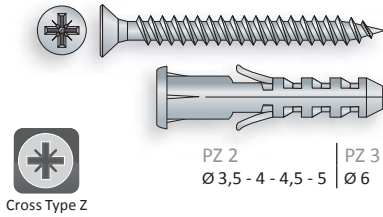

Item code	Anchor Size Ø x La (mm)	Screw Size Ø x Ls (mm)	Pcs. per box	Pcs. per carton
<b>AX 10 04 020</b>	4 x 20	3,5 x 30	200	10.000
<b>AX 10 05 025</b>	5 x 25	3,5 x 30	200	10.000
<b>AX 10 06 030</b>	6 x 30	4 x 40	100	5.000
<b>AX 25 06 030</b>	6 x 30	4,5 x 40	100	5.000
<b>AX 10 08 040</b>	8 x 40	5 x 50	50	2.500
<b>AX 10 10 050</b>	10 x 50	6 x 60	25	1.250

#### Usage / Utilisation / Benutzung / Uso / Применение

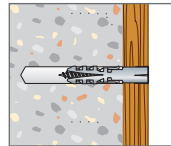

#### Box / Boîte / Verpackung / Caja / Упаковка



#### Set box and EasyBox



Available in set box (Item code: **SE01** - pag. 206), and in "EasyBox" display unit (see "T-Store - Merchandising" section).

Minimum Order Quantity: 1 carton

### **AX 13** 10 sets bag packing / sachets de 10 pcs / 10 St. im Beutel / 10 unidades en cada bolsa / в мешочке по 10 шт

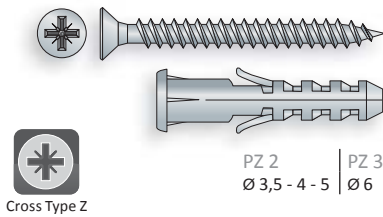

Item code	Anchor Size Ø x La (mm)	Screw Size Ø x Ls (mm)	Pcs. per bag	Pcs. per carton
<b>AX 13 04 020</b>	4 x 20	3,5 x 30	10	100
<b>AX 13 05 025</b>	5 x 25	3,5 x 30	10	100
<b>AX 13 06 030</b>	6 x 30	4 x 40	10	100
<b>AX 13 08 040</b>	8 x 40	5 x 50	10	50
<b>AX 13 10 050</b>	10 x 50	6 x 60	10	25



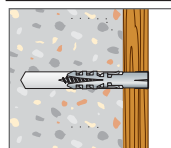

#### Usage / Utilisation / Benutzung / Uso / Применение







#### Box / Boîte / Verpackung / Caja / Упаковка



# SE 01

 Until stockout  
 Jusqu'à épuisement de stocks  
 Solange der Vorrat reicht  
 Hasta agotar existencias  
 до окончания стока

## 🇬🇧 Rimless nylon wall plug with Flat CSK head chipboard screw, 440 pcs. plastic box

-  Chevilles en nylon sans collerette, avec vis tête fraisée plate pour panneaux de particules, 440 pcs. dans une boîte de plastique
-  Nylondübel ohne Saum mit Spanplatten- Senkkopfschraube, 440 St. in einer Plastikverpackung
-  Taco de nylon sin collarín con tornillo cabeza avellanada para aglomerado, 440 unidades en cada caja de plástico
-  Нейлоновый дюбель без борта в комплекте с шурупом с плоской потайной головкой, 440 шт в пластиковой коробке



Item code	Pcs. per box	Box per Carton
SE 01 00 440	440	6

Box / Boîte / Verpackung / Caja / Упаковка





6 box per Carton.







Box contents / contenu de la boîte de plastique / Inhalt der Plastikverpackung / Contenido de la caja / В наборе



# SE 02

 Until stockout  
 Jusqu'à épuisement de stocks  
 Solange der Vorrat reicht  
 Hasta agotar existencias  
 до окончания стока

## 🇬🇧 Rimmed nylon wall plug with Flat CSK head chipboard screw, 420 pcs. plastic box

-  Chevilles en nylon avec collerette, avec vis tête fraisée plate pour panneaux de particules, 420 pcs. dans une boîte de plastique
-  Nylondübel mit Saum mit Spanplatten- Senkkopfschraube, 420 St. in einer Plastikverpackung
-  Taco de nylon con collarín con tornillo cabeza avellanada para aglomerado, 420 unidades en cada caja de plástico
-  Нейлоновый дюбель с бортом в комплекте с шурупом с плоской потайной головкой, 420 шт в пластиковой коробке



Item code	Pcs. per box	Box per Carton
SE 02 00 420	420	6

Box / Boîte / Verpackung / Caja / Упаковка





6 box per Carton.

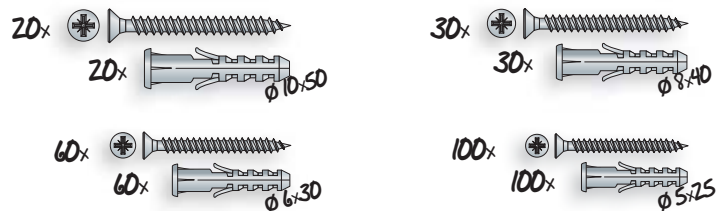



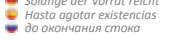

Box contents / contenu de la boîte de plastique / Inhalt der Plastikverpackung / Contenido de la caja / В наборе

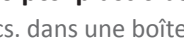

# SE 11

 Until stockout  
 Jusqu'à épuisement de stocks  
 Solange der Vorrat reicht  
 Hasta agotar existencias  
 До окончания стока

-  **Nylon anchors assortment, 266 pcs. plastic box**
-  Chevilles en nylon assortis, 266 pcs. dans une boîte de plastique
-  Sortiment von Nylandübel, 266 St.in einer Plastikverpackung
-  Surtido de tacos de nylon, 266 unidades en cada caja de plástico
-  Нейлоновые дюбели в ассортименте, 266 шт в пластиковой коробке



Item code	Pcs. per box	Box per Carton
SE 11 00 266	266	6

Box / Boîte / Verpackung / Caja / Упаковка  
6 box per Carton.



Box contents / contenu de la boîte de plastique / Inhalt der Plastikverpackung / Contenido de la caja / В наборе

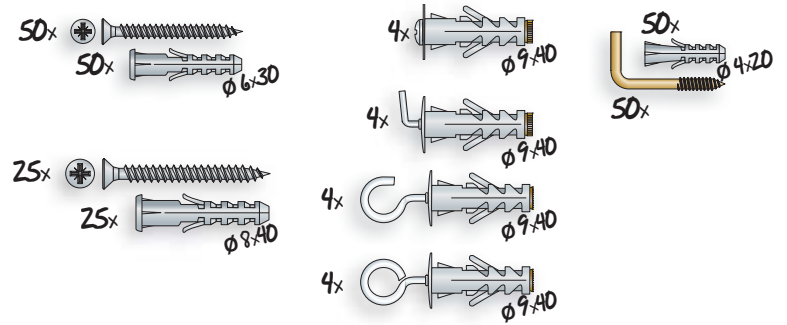

### EasyBox



Available in SPECIAL OFFER in "EasyBox" (see "T-Store - Merchandising" section).

# LA 01

## 🇬🇧 Rimless nylon wall plug with brass plated steel "L" screw, 10 sets bag packing

- 🇫🇷 Cheville en nylon sans collerette, avec vis crochet en laiton, sachets de 10 pcs
- 🇩🇪 Nyldübel ohne Saum, mit Hakenschraube aus Messing, 10 St. im Beutel
- 🇪🇸 Taco de nylon sin collarín con gancho de acero latonado, 10 unidades en cada bolsa
- 🇷🇺 Нейлоновый дюбель без борта с прямоугольным латунным крюком, в мешочке по 10 шт

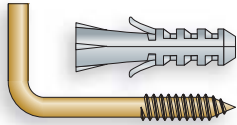

Item code	Anchor Size $\varnothing \times La$ (mm)	Screw Size $\varnothing \times Ls$ (mm)	Bags per Box	Bags per carton
LA 01 04 020	4 x 20	3 x 30	50	500

Box / Boîte / Verpackung / Caja / Упаковка



# MF - MG - MH - MJ

## 🇬🇧 Rimmed nylon plug with special screw with ring, 10 sets bag

- 🇫🇷 Cheville avec collerette avec vis spéciale avec anneau, sachets de 10 pcs
- 🇩🇪 Nyldübel mit Saum mit spezielle Schraube mit Ring, 10 St. im Beutel
- 🇪🇸 Taco de nylon con collarín con tornillo especial, 10 unidades en cada bolsa
- 🇷🇺 Нейлоновый дюбель с бортом и особым шурупом, в мешочке по 10 шт

### MF 01 with short "L" screw / avec crochet droit court / mit kurzem Haken / con gancho corto / с коротким крюком

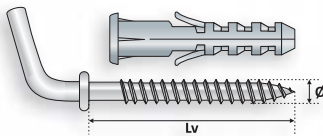

Item code	Anchor Size $\varnothing \times La$ (mm)	Screw Size $\varnothing \times Ls$ (mm)	Bags per box	Bags per carton
MF 01 06 030	6 x 30	4,5 x 35	10	100

### MG 01 with medium "L" screw / avec crochet droit longueur moyenne / mit Mittelhaken / con gancho medio / с крюком

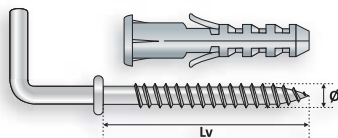

Item code	Anchor Size $\varnothing \times La$ (mm)	Screw Size $\varnothing \times Ls$ (mm)	Bags per box	Bags per carton
MG 01 06 030	6 x 30	4,5 x 35	10	100

### MH 01 with hook screw / avec crochet rond / mit Rundhaken / con gancho curvo / с потолочным крюком

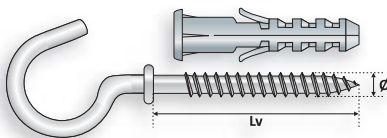

Item code	Anchor Size $\varnothing \times La$ (mm)	Screw Size $\varnothing \times Ls$ (mm)	Bags per box	Bags per carton
MH 01 06 030	6 x 30	4,5 x 35	10	100

### MJ 01 with eye screw / avec oeillet / mit Augenschraube / con argolla / с замкнутым крюком

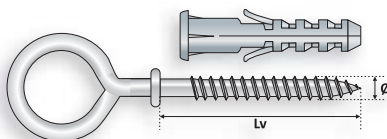

Item code	Anchor Size $\varnothing \times La$ (mm)	Screw Size $\varnothing \times Ls$ (mm)	Bags per box	Bags per carton
MJ 01 06 030	6 x 30	4,5 x 35	10	100

Box / Boîte / Verpackung / Caja / Упаковка





# AZ

**🇬🇧 Rimless anchor with special hardened and zinc plated hexagonal head wood screw, and flat washer**

- 🇫🇷** Cheville sans collerette, avec vis à bois tête hexagonale spéciale, en acier cémenté, zinguée et rondelle
- 🇩🇪** Dübel ohne Saum mit Sechskant-Holzschraube, einsetzgehärtet und Unterlegscheibe
- 🇪🇸** Taco sin collarín con tornillo especial para madera con cabeza hexagonal, de acero cementado cincado y con arandela
- 🇷🇺** Дюбель без борта со специальным шурупом из закаленной оцинкованной стали с шестигранной головкой, и с плоской шайбой

**AZ 01** Nylon / Nylon / Nylon / Nylon / нейлон

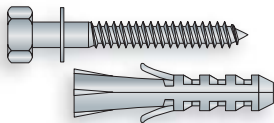

Item code	Anchor Size Ø x La (mm)	Screw Size Ø x Ls (mm)	Pcs. per box	Pcs. per carton
AZ 01 08 040	8 x 40	6 x 50	100	1.000
AZ 01 10 050	10 x 50	7 x 65	50	500
AZ 01 12 060	12 x 60	8 x 70	50	500
AZ 01 14 080	14 x 75	10 x 100	50	250
AZ 01 14 100	14 x 100	10 x 120	25	250
AZ 01 16 080	16 x 80	12 x 100	25	250

**AZ 02** Polypropylene / Polypropylène / Polipropilene / Polipropileno / полипропилен

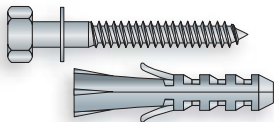

Item code	Anchor Size Ø x La (mm)	Screw Size Ø x Ls (mm)	Pcs. per box	Pcs. per carton
AZ 02 14 080	14 x 75	10 x 100	50	250

Box / Boîte / Verpackung / Caja / Упаковка



# BV

**🇬🇧 Nylon anchor with zinc plated steel conical expansion nut**

- 🇫🇷** Cheville en nylon avec écrou en laiton à expansion
- 🇩🇪** Nyldübel mit Spreiz- Schraubenmutter aus Messing
- 🇪🇸** Taco de nylon con tuerca cónica de acero cincado
- 🇷🇺** Нейлоновый дюбель со стальной конусной гайкой



Item code	Anchor Size Ø x La (mm)	Pcs. per box	Pcs. per carton
BV 01 12 070	12 x 70	100	1.000
BV 01 14 075	14 x 75	50	500

**BV 02** with hex head machine screw / avec vis tête hexagonale / mit Sechskantschraube / con tornillo cabeza hexagonal / в комплекте с шурупом с шестигранной головкой

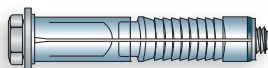

Item code	Anchor Size Ø x La (mm)	Screw Size M x Ls (mm)	Pcs. per box	Pcs. per carton
BV 02 12 070	12 x 70	M8 x 80	100	500
BV 02 14 075	14 x 75	M10 x 80	50	250

Box / Boîte / Verpackung / Caja / Упаковка



# AY 01

**AY 01 - Nylon anchor with zinc plated M4/M5 combi oval countersunk head screw, zinc plated steel washer and conical nut**

- Cheville en nylon avec vis tête fraisée M4/M5, rondelle zinguée et écrou conique
- Nylondübel mit Senkkopfschraube mit Kreuzschlitz M4/M5, Scheibe und könischer Schraubenmutter
- Taco de nylon con tornillo M4/M5 con cabeza avellanada abombada, arandela y cono de acero cincado
- Нейлоновый дюбель в комплекте с оцинкованным шурупом M4/M5 с овальной потайной головкой с комбинированным шлицем, с оцинкованной стальной шайбой и конической гайкой

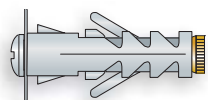

Item code	Anchor Size ∅ x La (mm)	Screw Size M x Ls (mm)	Pcs. per box	Pcs. per carton
AY 01 09 040	9 x 40	M4 x 50	200	2.000
AY 01 12 045	12 x 45	M5 x 50	100	1.000

# AY

**AY 02 - Nylon washer anchor with zinc plated M4/M5 short "L" screw with ring and zinc plated steel conical nut**

- AY 02 - Cheville en nylon avec crochet droit court M4/M5 et écrou conique
- AY 02 - Nylondübel mit kurzem Haken M4/M5 und könischer Schraubenmutter
- AY 02 - Taco de nylon con gancho corto M4/M5 y cono de acero cincado
- AY 02 - Нейлоновый дюбель в комплекте с оцинкованным коротким прямым крюком M4/M5 с шайбой и оцинкованной стальной конической гайкой

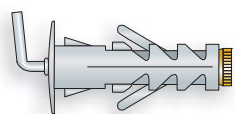

Item code	Anchor Size ∅ x La (mm)	Screw Size M x Ls (mm)	Pcs. per box	Pcs. per carton
AY 02 09 040	9 x 40	M4 x 43	200	2.000
AY 02 12 045	12 x 45	M5 x 48	100	1.000

**AY 03** with medium "L" screw / avec crochet droit longueur moyenne / mit Mittelhaken / con gancho medio / с прямым крюком

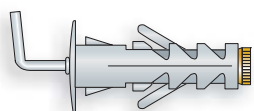

Item code	Anchor Size ∅ x La (mm)	Screw Size M x Ls (mm)	Pcs. per box	Pcs. per carton
AY 03 09 040	9 x 40	M4 x 43	200	2.000
AY 03 12 045	12 x 45	M5 x 48	100	1.000

**AY 04** with long "L" screw / avec crochet droit long / mit Langhaken / con gancho largo / с длинным прямым крюком

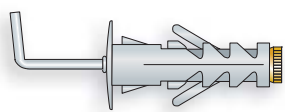

Item code	Anchor Size ∅ x La (mm)	Screw Size M x Ls (mm)	Pcs. per box	Pcs. per carton
AY 04 09 040	9 x 40	M4 x 43	200	2.000
AY 04 12 045	12 x 45	M5 x 48	100	1.000

# AY 05



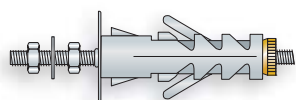

**AY 05 - Nylon anchor with zinc plated M4/M5 dual thread screw, zinc plated steel washer and conical nut**

- Cheville en nylon avec vis M4/M5 double filet, rondelle zinguée et écrou conique
- Nylondübel mit Doppelgewindeschraube, mit verzinkter Scheibe und könischer Schraubenmutter
- Taco de nylon con tornillo doble rosca M4/M5, arandela y cono de acero cincado
- Нейлоновый дюбель в комплекте с оцинкованным шурупом M4/M5 с двойной резьбой, с оцинкованной стальной шайбой и конической гайкой



Item code	Anchor Size ∅ x La (mm)	Screw Size M x Ls (mm)	Pcs. per box	Pcs. per carton
AY 05 09 040	9 x 40	M4 x 43	100	1.000
AY 05 12 045	12 x 45	M5 x 48	50	500

# AY

-  **AY 06 - Nylon washer anchor with zinc plated M4/M5 hook screw with ring and zinc plated steel conical nut**
-  AY 06 - Cheville en nylon avec crochet rond M4/M5 et écrou conique
-  AY 06 - Nylandübel mit Rundhaken M4/M5 und könischer Schraubenmutter
-  AY 06 - Taco de nylon con gancho curvo M4/M5 y cono de acero cincado
-  AY 06 - Нейлоновый дюбель в комплекте с оцинкованным потолочным крюком M4/M5 с шайбой и оцинкованной стальной конической гайкой

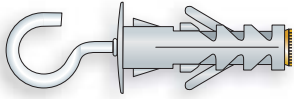

<i>Item code</i>	<i>Anchor Size</i> Ø x La (mm)	<i>Screw Size</i> M x Ls (mm)	<i>Pcs. per box</i>	<i>Pcs. per carton</i>
<b>AY 06 09 040</b>	9 x 40	M4 x 43	100	1.000
<b>AY 06 12 045</b>	12 x 45	M5 x 48	100	1.000

**AY 07** with eye screw / avec oeillet / mit Augenschraube / con argolla / с замкнутым крюком

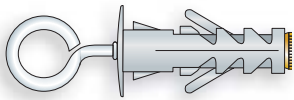

<i>Item code</i>	<i>Anchor Size</i> Ø x La (mm)	<i>Screw Size</i> M x Ls (mm)	<i>Pcs. per box</i>	<i>Pcs. per carton</i>
<b>AY 07 09 040</b>	9 x 40	M4 x 43	100	1.000
<b>AY 07 12 045</b>	12 x 45	M5 x 48	100	1.000

Box / Boîte / Verpackung / Caja / Упаковка



# AY

Extended series / série rallongée / verlängerte Serie / serie larga / Удлиненная серия

**AY 08 - Extended nylon anchor with zinc plated M4/M5 combi oval countersunk head screw, zinc plated steel washer and conical nut**

AY 08 - Cheville en nylon rallongée avec vis tête fraisée M4/M5, rondelle zinguée et écrou conique

AY 08 - Verlängerter Nylondübel mit Senkkopfschraube mit Kreuzschlitz M4/M5, mit verzinkter Scheibe und könischer Schraubenmutter

AY 08 - Taco largo de nylon con tornillo M4/M5 con cabeza avellanada abombada, arandela y cono de acero cincado

AY 08 - Удлиненный нейлоновый дюбель в комплекте с оцинкованным шурупом M4/M5 с овальной потайной головкой с комбинированным шлицем, с оцинкованной стальной шайбой и конической гайкой

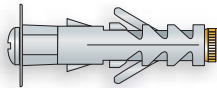

Item code	Anchor Size Ø x La (mm)	Screw Size M x Ls (mm)	Pcs. per box	Pcs. per carton
AY 08 09 050	9 x 50	M4 x 60	100	1.000
AY 08 12 057	12 x 57	M5 x 65	100	1.000

**AY 09** with short "L" screw / avec crochet droit court / mit kurzem Haken / con gancho corto / с коротким прямым крюком

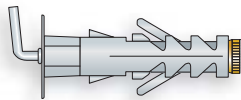

Item code	Anchor Size Ø x La (mm)	Screw Size M x Ls (mm)	Pcs. per box	Pcs. per carton
AY 09 09 050	9 x 50	M4 x 60	100	1.000
AY 09 12 057	12 x 57	M5 x 65	100	1.000

**AY 10** with medium "L" screw / avec crochet droit longueur moyenne / mit Mittelhaken / con gancho medio / с прямым крюком

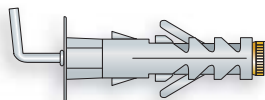

Item code	Anchor Size Ø x La (mm)	Screw Size M x Ls (mm)	Pcs. per box	Pcs. per carton
AY 10 09 050	9 x 50	M4 x 60	100	1.000
AY 10 12 057	12 x 57	M5 x 65	100	1.000

**AY 11** with hook screw / avec crochet rond / mit Rundhaken / con gancho curvo / с потолочным крюком

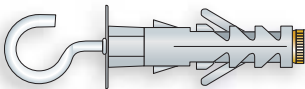

Item code	Anchor Size Ø x La (mm)	Screw Size M x Ls (mm)	Pcs. per box	Pcs. per carton
AY 11 09 050	9 x 50	M4 x 60	100	1.000
AY 11 12 057	12 x 57	M5 x 65	50	500

**AY 12** with eye screw / avec oeillet / mit Augenschraube / con argolla / с замкнутым крюком

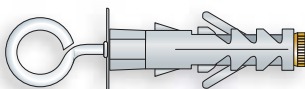

Item code	Anchor Size Ø x La (mm)	Screw Size M x Ls (mm)	Pcs. per box	Pcs. per carton
AY 12 09 050	9 x 50	M4 x 60	100	1.000
AY 12 12 057	12 x 57	M5 x 65	50	500



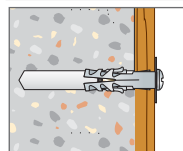

Usage / Utilisation / Benutzung / Uso / Применение



Box / Boîte / Verpackung / Caja / Упаковка





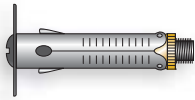

# DY 01

-  **Zinc plated steel anchor with M4/M5 combi oval countersunk head screw, zinc plated steel washer and conical nut**
-  Cheville zinguée avec vis tête fraisée M4/M5 et écrou conique
-  Verzinkter Dübel mit Senkkopfschraube mit Kreuzschlitz M4/M5 und könischer Schraubenmutter
-  Taco de acero cincado con tornillo M4/M5 con cabeza avellanada abombada y cono de acero cincado
-  Оцинкованный стальной дюбель в комплекте с шурупом M4/M5 с овальной потайной головкой с комбинированным шлицем и с оцинкованной стальной конической гайкой



Item code	Anchor Size ∅ x La (mm)	Screw Size M x Ls (mm)	Pcs. per box	Pcs. per carton
DY 01 08 035	8 x 35	M4 x 50	200	2.000
DY 01 09 040	9 x 40	M5 x 55	100	1.000

# DY

-  **DY 02 - Zinc plated steel anchor with M4/M5 short "L" screw with ring and zinc plated steel conical nut**
-  DY 02 - Cheville zinguée avec crochet droit court M4/M5 et écrou conique
-  DY 02 - Verzinkter Dübel mit Senkkopfschraube mit Kreuzschlitz M4/M5 und könischer Schraubenmutter
-  DY 02 - Taco de acero cincado con gancho corto M4/M5 y cono de acero cincado
-  DY 02 - Оцинкованный стальной дюбель в комплекте с коротким прямым крюком M4/M5 и с оцинкованной стальной конической гайкой

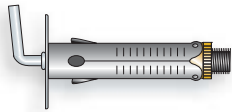

Item code	Anchor Size ∅ x La (mm)	Screw Size M x Ls (mm)	Pcs. per box	Pcs. per carton
DY 02 08 035	8 x 35	M4 x 43	200	2.000
DY 02 09 040	9 x 40	M5 x 48	100	1.000

**DY 03** with medium "L" screw / avec crochet droit longueur moyenne / mit Mittelhaken / con gancho medio / с прямым крюком

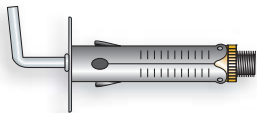



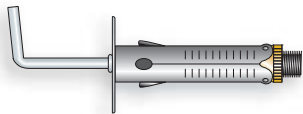

Item code	Anchor Size ∅ x La (mm)	Screw Size M x Ls (mm)	Pcs. per box	Pcs. per carton
DY 03 08 035	8 x 35	M4 x 43	200	2.000
DY 03 09 040	9 x 40	M5 x 48	100	1.000

**DY 04** with long "L" screw / avec crochet droit long / mit Langhaken / con gancho largo / с длинным прямым крюком



Item code	Anchor Size ∅ x La (mm)	Screw Size M x Ls (mm)	Pcs. per box	Pcs. per carton
DY 04 08 035	8 x 35	M4 x 43	200	2.000
DY 04 09 040	9 x 40	M5 x 48	100	1.000

# DY 05

-  **Zinc plated steel anchor with M4/M5 dual thread screw, zinc plated steel washer and conical nut**
-  Cheville zinguée avec vis M4/M5 double filet, rondelle zinguée et écrou conique
-  Verzinkter Dübel mit Doppelgewindeschraube, mit verzinkter Scheibe und könischer Schraubenmutter
-  Taco de acero cincado con tornillo doble rosca M4/M5, arandela y cono de acero cincado
-  Оцинкованный стальной дюбель в комплекте с шурупом с двойной резьбой M4/M5 и с оцинкованной стальной конической гайкой

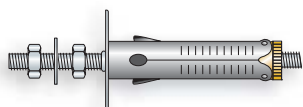

Item code	Anchor Size ∅ x La (mm)	Screw Size M x Ls (mm)	Pcs. per box	Pcs. per carton
DY 05 08 035	8 x 35	M4 x 43	100	1.000
DY 05 09 040	9 x 40	M5 x 48	100	1.000



# DY

## **DY 06 - Zinc plated steel anchor with M4/M5 hook screw with ring and zinc plated steel conical nut**

 DY 06 - Cheville zinguée avec crochet rond M4/M5 et écrou conique

 DY 06 - Verzinkter Dübel mit Rundhaken M4/M5 und könischer Schraubenmutter

 DY 06 - Taco de acero cincado con gancho curvo M4/M5 y cono de acero cincado

 DY 06 - Оцинкованный стальной дюбель в комплекте с потолочным крюком M4/M5 и с оцинкованной стальной конической гайкой

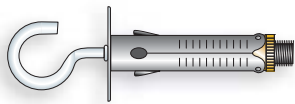

Item code	Anchor Size	Screw Size	Pcs. per box	Pcs. per carton
	∅ x La (mm)	M x Ls (mm)		
DY 06 08 035	8 x 35	M4 x 43	100	1.000
DY 06 09 040	9 x 40	M5 x 48	100	1.000

## **DY 07** with eye screw / avec oeillet / mit Augenschraube / con argolla / с замкнутым крюком

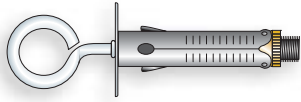

Item code	Anchor Size	Screw Size	Pcs. per box	Pcs. per carton
	∅ x La (mm)	M x Ls (mm)		
DY 07 08 035	8 x 35	M4 x 43	100	1.000
DY 07 09 040	9 x 40	M5 x 48	100	1.000

# DY

*Extended series / série rallongée / verlangerte Serie / serie larga / Удлиненная серия*

## **DY 08 - Extended zinc plated steel anchor with M4/M5 combi oval countersunk head screw, zinc plated steel washer and conical nut**

 DY 08 - Cheville zinguée rallongée avec vis tête fraisée M4/M5 et écrou conique

 DY 08 - Verlängerter und verzinkter Dübel mit Senkkopfschraube mit Kreuzschlitz M4/M5 und könischer Schraubenmutter

 DY 08 - Taco largo de acero cincado con tornillo M4/M5 con cabeza avellanada abombada, arandela y cono de acero cincado

 DY 08 - Удлиненный оцинкованный стальной дюбель в комплекте с шурупом M4/M5 с овальной потайной головкой с комбинированным шлицем, и с оцинкованной стальной конической гайкой

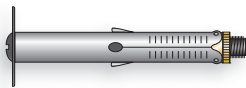

Item code	Anchor Size	Screw Size	Pcs. per box	Pcs. per carton
	∅ x La (mm)	M x Ls (mm)		
DY 08 09 050	9 x 50	M5 x 65	100	1.000

## **DY 09** with short "L" screw / avec crochet droit court / mit kurzem Haken / con gancho corto / с коротким прямым крюком

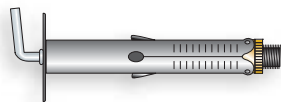

Item code	Anchor Size	Screw Size	Pcs. per box	Pcs. per carton
	∅ x La (mm)	M x Ls (mm)		
DY 09 09 050	9 x 50	M5 x 65	100	1.000

## **DY 10** with eye screw / avec oeillet / mit Augenschraube / con argolla / с замкнутым крюком

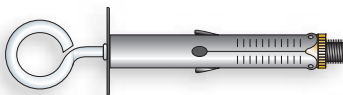

Item code	Anchor Size	Screw Size	Pcs. per box	Pcs. per carton
	∅ x La (mm)	M x Ls (mm)		
DY 10 09 050	9 x 50	M5 x 65	100	1.000

Usage / Utilisation / Benutzung / Uso / Применение

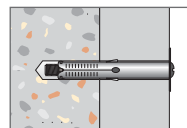

Box / Boîte / Verpackung / Caja / Упаковка



# DY

**DY 13 - Zinc plated steel anchor (Ø 6) with M3 combi oval countersunk head screw, zinc plated steel washer and conical nut**

DY 13 - Cheville en acier zingué (Ø 6) avec vis tête fraisée M3 et écrou conique

DY 13 - Verzinkter Dübel (Ø 6) mit verzinkter Senkkopfschraube M3 mit Kreuzschlitz und könischer Schraubennutter

DY 13 - Taco de acero cincado (Ø 6) con tornillo M3 con cabeza avellanada abombada, arandela y cono de acero cincado

DY 13 - Оцинкованный стальной дюбель (Ø 6) в комплекте с шурупом М3 с овальной потайной головкой с комбинированным шлицем, и с оцинкованной стальной конической гайкой

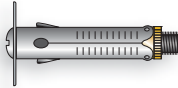

Item code	Anchor Size Ø x La (mm)	Screw Size M x Ls (mm)	Pcs. per box	Pcs. per carton
DY 13 06 030	6 x 30	M3 x 30	200	2.000

**DY 14** with short "L" screw / avec crochet droit court / mit kurzem Haken / con gancho corto / с коротким прямым крюком

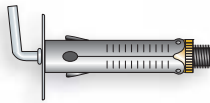

Item code	Anchor Size Ø x La (mm)	Screw Size M x Ls (mm)	Pcs. per box	Pcs. per carton
DY 14 06 030	6 x 30	M3 x 30	200	2.000

**DY 15** with hook screw / avec crochet rond / mit Rundhaken / con gancho curvo / с потолочным крюком

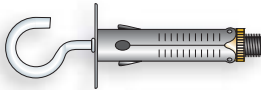

Item code	Anchor Size Ø x La (mm)	Screw Size M x Ls (mm)	Pcs. per box	Pcs. per carton
DY 15 06 030	6 x 30	M3 x 30	200	2.000

**DY 16** with eye screw / avec oeillet / mit Augenschraube / con argolla / с замкнутым крюком

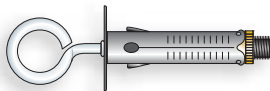

Item code	Anchor Size Ø x La (mm)	Screw Size M x Ls (mm)	Pcs. per box	Pcs. per carton
DY 16 06 030	6 x 30	M3 x 30	200	2.000

Box / Boîte / Verpackung / Caja / Упаковка



# DM 01

## 🇬🇧 Zinc alloy hammer fixing with zinc plated steel nail

- 🇫🇷 Cheville avec clou à marteler en alliage de zinc
- 🇩🇪 Nageldübel aus Zinklegierung zu hämmern
- 🇪🇸 Taco de golpe de aleación de cinc montado con clavo de acero cincado
- 🇷🇺 Ударный дюбель из оцинкованного сплава со стальным оцинкованным гвоздем



Item code	Anchor Size Ø x La (mm)	Pcs. per box	Pcs. per carton
Ø 5			
DM 01 05 022	5 x 22	200	2.000
Ø 6			
DM 01 06 020	6 x 20	200	2.000
DM 01 06 030	6 x 30	200	2.000
DM 01 06 040	6 x 40	200	2.000
DM 01 06 050	6 x 50	200	2.000
DM 01 06 065	6 x 65	100	1.000

Usage / Utilisation / Benutzung / Uso / Применение

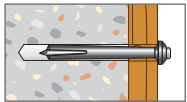

Box / Boîte / Verpackung / Caja / Упаковка



# LU - LY

## 🇬🇧 Pre-galvanized steel large washer for insulated panels fixing with screw or nylon anchor

- 🇫🇷 Rondelle en acier pré-zingué, pour panneaux d'isolation avec vis ou cheville en nylon
- 🇩🇪 Verzinkte Scheibe, für Befestigung von Isolierplatte mit Schraube oder Nypondübel
- 🇪🇸 Arandela ancha de acero pregalvanizado para paneles aislantes
- 🇷🇺 Прижимной стальной диск с конусообразным отверстием для крепления изоляционных панелей

**LU 01** with countersunk hole / avec trou fraisé / mit Senkloch / con agujero avellanado / с конусообразным отверстием

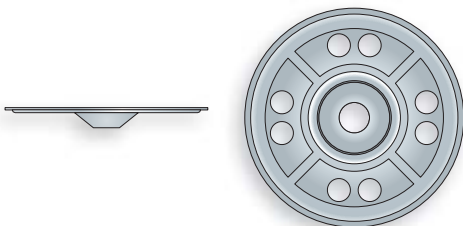

Item code	Size Ø int x Ø ext x Thick. (mm)	Pcs. per box	Pcs. per carton
LU 01 06 070	6,5 x 70 x 0,7	100	1.000
LU 01 09 070	9 x 70 x 0,7	100	1.000

**LY 01** with flat hole / avec trou plate / mit Flachloch / con agujero plano / с плоским отверстием

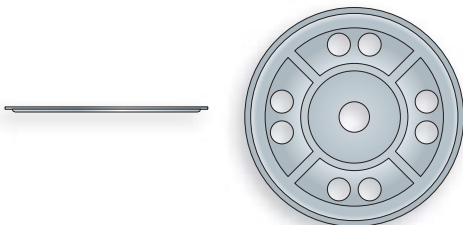

Item code	Size Ø int x Ø ext x Thick. (mm)	Pcs. per box	Pcs. per carton
LY 01 65 070	6,5 x 70 x 0,7	100	1.000
LY 01 90 070	9 x 70 x 0,7	100	1.000

Usage / Utilisation / Benutzung / Uso / Применение

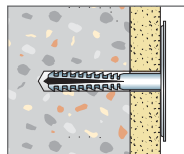

Box / Boîte / Verpackung / Caja / Упаковка



# JL 01

**Polypropylene anchor with fiber-glass reinforced nylon nail, for insulating panels fixing on concrete**

Cheville en polypropylène avec clou chargé de fibre de verre, pour panneaux d'isolation sur béton

Dübel aus Additivpolypropylen mit Nagel mit Glasfaser, für Befestigung von Isolierplatte auf Beton

Taco de polipropileno con clavo de nylon reforzado con fibra de vidrio para la fijación de paneles aislantes sobre hormigón

Полипропиленовый анкер с армированным стекловолокном стержнем из нейлона для крепления изоляционных панелей к бетону



Item code	Anchor Size Ø x Lt (mm)	Fixture thickness max (mm)	Disk diameter (mm)	Pcs. per carton
JL 01 10 060	10 x 60	20	53	200
JL 01 10 070	10 x 70	30	53	200
JL 01 10 090	10 x 90	50	53	200
JL 01 10 110	10 x 110	70	53	200
JL 01 10 130	10 x 130	90	53	200
JL 01 10 150	10 x 150	110	58	200
JL 01 10 180	10 x 180	140	58	200
JL 01 10 210	10 x 210	170	58	150
JL 01 10 240	10 x 240	200	58	100

Usage / Utilisation / Benutzung / Uso / Применение

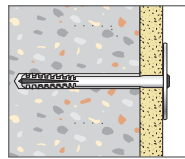

Box / Boîte / Verpackung / Caja / Упаковка



# BN 01

**Polypropylene anchor for insulating panels fixing on concrete; disk diameter 40 mm**

Cheville en polypropylène additivé d'isolation, pour panneaux d'isolation sur béton, diamètre du disque 40mm

Dübel aus Additivpolypropylen, für Befestigung von Isolierplatte auf Beton, Durchmesser der Scheibe 40 mm

Taco de polipropileno para la fijación de paneles aislantes sobre hormigón; diámetro disco 40 mm

Полипропиленовый анкер для крепления изоляционных панелей к бетону; диаметр диска 40 мм



Item code	Anchor Size Ø x La (mm)	Fixture thickness min - max (mm)	Disk diameter (mm)	Pcs. per carton
<i>New Item</i> BN 01 08 050	8 x 50	8	10 - 20	500
<i>New Item</i> BN 01 08 070	8 x 70	8	20 - 40	400
BN 01 08 085	8 x 85	8	40 - 60	300
<i>New Item</i> BN 01 08 110	8 x 110	8	60 - 80	300
<i>New Item</i> BN 01 08 130	8 x 130	8	80 - 100	300

Usage / Utilisation / Benutzung / Uso / Применение

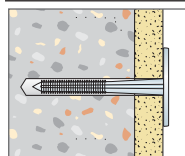

Box / Boîte / Verpackung / Caja / Упаковка



# HG

# Stop&GO®

**🇬🇧 Magnetic door stop, with floor and door fixing accessories**

**🇫🇷** Ferme-porte magnetique avec accessoires pour la fixation sur le sol et la porte

**🇩🇪** Magnetischer Türschließer mit Boden- und Türzubehöre

**🇪🇸** Tope de puertas magnético, con accesorios para la fijación al suelo y a la puerta

**🇷🇺** Магнитный ограничитель открывания двери с комплектующими для напольного и дверного крепления



Item code	Finition	Pcs. per box	Pcs. per carton
HG 01 45 037	Shiny Gold	6	24
HG 02 45 037	Satiny Gold	6	24
HG 03 45 037	Shiny Chromium	6	24
HG 04 45 037	Satiny Chromium	6	24
HG 05 45 037	Bronzed	6	24

Box / Boîte / Verpackung / Caja / Упаковка



Installation sequece / Instructions de mise en oeuvre / Setzanweisung / Secuencia de instalación / Порядок монтажа

