























 Drills for metals	<ul style="list-style-type: none">  Forets pour métaux  Bohrer von Metall  Brocas para metal  Сверла по металлу 	378
	 Masonry drills	<ul style="list-style-type: none">  Forets pour mur  Bohrer von Mauer  Brocas para hormigón  Сверла по бетону 	383
	 Assorted drill bits Set	<ul style="list-style-type: none">  Assortiment de forets  Bohrer-Sortiment  Surtido de brocas  Набор сверл 	387
	 Bit Holders	<ul style="list-style-type: none">  Douille pour visseuse  Bits-Halter für Schrauber  Portapuntas de atornillar  держатель биты 	388
	 Bits	<ul style="list-style-type: none">  Embouts de vissage  Bits für Schrauber  Puntas de atornillar  биты 	389
	 Sockets	<ul style="list-style-type: none">  Carote magnétique  Magnetische Steckeinschüsseinsätze  Bocas  Насадка 	392
	 Screwy® - Screwdriver bits set	<ul style="list-style-type: none">  Screwy® - Série d' embouts de vissage avec kit tournevis  Screwy® - Bit-Serie mit Schraubenzieher-Kit  Screwy® - Surtido de puntas de atornillar  Screwy® - Набор битов 	394

Fixing tools and accessories

-  Outils et Accessoires de fixation
-  Befestigungswerkzeuge und Zubehör
-  Brocas y Herramientas
-  Инструменты и аксессуары

EK 01

 **DIN 338 N - HSS straight shank twist drill for metals, rollforged right screw, black finishing short series**

 DIN 338 N - HSS foret hélicoïdal à queue cylindrique, finition noire, série courte

 DIN 338 N - HSS Schwarzer gerollter Spiralbohrer mit Zylinderschaft, kurze Ausführung

 DIN 338 N - HSS broca helicoidal con mango cilíndrico para metal, redoblada, acabado negro, serie corta

 DIN 338 тип N - HSS сверло по металлу с роликовой прокаткой, цилиндрический хвостовик, черное покрытие, короткая серия

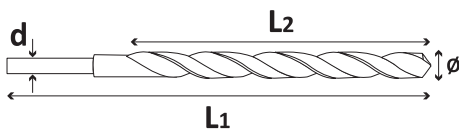





Box / Boîte / Verpackung / Caja / Упаковка



Item code	Size			Pcs. per box
	Ø	L2	L1	
EK 01 00 100	1	12	34	10
EK 01 00 150	1,5	18	40	10
EK 01 00 175	1,75	22	46	10
EK 01 00 200	2	24	49	10
EK 01 00 225	2,25	27	53	10
EK 01 00 250	2,5	30	57	10
EK 01 00 275	2,75	33	61	10
EK 01 00 300	3	33	61	10
EK 01 00 325	3,25	36	65	10
EK 01 00 350	3,5	39	70	10
EK 01 00 375	3,75	39	70	10
EK 01 00 400	4	43	75	10
EK 01 00 425	4,25	43	75	10
EK 01 00 450	4,5	47	80	10
EK 01 00 475	4,75	47	80	10
EK 01 00 500	5	52	86	10
EK 01 00 525	5,25	52	86	10
EK 01 00 550	5,5	57	93	10
EK 01 00 575	5,75	57	93	10
EK 01 00 600	6	57	93	10
EK 01 00 625	6,25	63	101	10
EK 01 00 650	6,5	63	101	10
EK 01 00 675	6,75	69	109	10
EK 01 00 700	7	69	109	10
EK 01 00 725	7,25	69	109	10
EK 01 00 750	7,5	69	109	10
EK 01 00 775	7,75	75	117	10
EK 01 00 800	8	75	117	10
EK 01 00 825	8,25	75	117	10
EK 01 00 850	8,5	75	117	10
EK 01 00 875	8,75	81	125	10
EK 01 00 900	9	81	125	10
EK 01 00 925	9,25	81	125	10
EK 01 00 950	9,5	81	125	10
EK 01 00 975	9,75	87	133	10
EK 01 01 000	10	87	133	10
EK 01 01 025	10,25	87	133	5
EK 01 01 050	10,5	87	133	5
EK 01 01 075	10,75	94	142	5
EK 01 01 100	11	94	142	5
EK 01 01 125	11,25	94	142	5
EK 01 01 150	11,5	94	142	5
EK 01 01 175	11,75	94	142	5
EK 01 01 200	12	101	151	5
EK 01 01 250	12,5	101	151	5
EK 01 01 300	13	101	151	5
EK 01 01 350	13,5	108	160	1
EK 01 01 400	14	108	160	1
EK 01 01 450	14,5	114	169	1
EK 01 01 500	15	114	169	1
EK 01 01 550	15,5	120	178	1
EK 01 01 600	16	120	178	1
EK 01 01 650	16,5	125	186	1
EK 01 01 700	17	125	186	1
EK 01 01 750	17,5	130	194	1
EK 01 01 800	18	130	194	1
EK 01 01 850	18,5	135	202	1
EK 01 01 900	19	135	202	1
EK 01 01 950	19,5	140	210	1
EK 01 02 000	20	140	210	1

EL 01

-  **DIN 338 N - HSS straight shank twist drill for metals, fully ground from the solid, bright finishing, short series**
-  **DIN 338 N - foret hélicoïdal HSS mèche à queue cylindrique, recoltée du plein, polie, série courte**
-  **DIN 338 N - Blanker HSS Spiralbohrer mit Zylinderschaft, aus dem Vollen geschliffen, kurze Ausführung**
-  **DIN 338 N - HSS broca helicoidal con mango cilíndrico para metal, obtenida de la pieza entera, acabado brillante, serie corta**
-  **DIN 338 тип N - HSS сверло по металлу из цельного материала, цилиндрический хвостовик, полностью шлифованное покрытие, короткая серия**

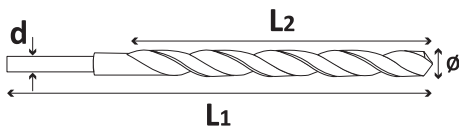
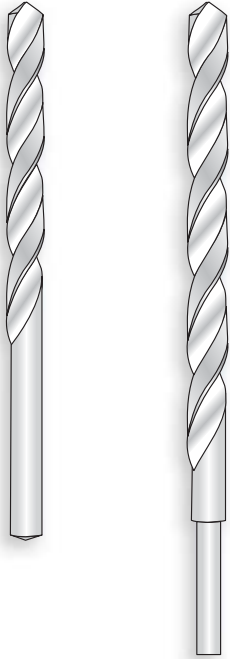





Item code	Size			Pcs. per box
	Ø	L2	L1	
EL 01 00 100	1	12	34	10
EL 01 00 150	1,5	18	40	10
EL 01 00 200	2	24	49	10
EL 01 00 225	2,25	27	53	10
EL 01 00 250	2,5	30	57	10
EL 01 00 275	2,75	33	61	10
EL 01 00 300	3	33	61	10
EL 01 00 325	3,25	36	65	10
EL 01 00 350	3,5	39	70	10
EL 01 00 375	3,75	39	70	10
EL 01 00 400	4	43	75	10
EL 01 00 425	4,25	43	75	10
EL 01 00 450	4,5	47	80	10
EL 01 00 475	4,75	47	80	10
EL 01 00 500	5	52	86	10
EL 01 00 525	5,25	52	86	10
EL 01 00 550	5,5	57	93	10
EL 01 00 575	5,75	57	93	10
EL 01 00 600	6	57	93	10
EL 01 00 625	6,25	63	101	10
EL 01 00 650	6,5	63	101	10
EL 01 00 675	6,75	69	109	10
EL 01 00 700	7	69	109	10
EL 01 00 750	7,5	69	109	10
EL 01 00 800	8	75	117	10
EL 01 00 850	8,5	75	117	10
EL 01 00 900	9	81	125	10
EL 01 00 950	9,5	81	125	10
EL 01 01 000	10	87	133	5
EL 01 01 100	11	94	142	5
EL 01 01 200	12	101	151	5
EL 01 01 300	13	101	151	5

Box / Boîte / Verpackung / Caja / Упаковка



EM 01

-  **DIN 340 N - HSS straight shank twist drill for metals, rollforged right screw, black finishing long series**
-  DIN 340 N - HSS foret hélicoïdal à queue cylindrique, finition noire, série longue
-  DIN 340 N - Schwarzer gerollter HSS Spiralbohrer mit Zylinderschaft, lange Ausführung
-  DIN 340 N - HSS broca helicoidal con mango cilíndrico para metal, redoblada, acabado negro, serie larga
-  DIN 340 тип N - HSS сверло по металлу с роликовой прокаткой, цилиндрический хвостовик, черное покрытие, удлиненная серия

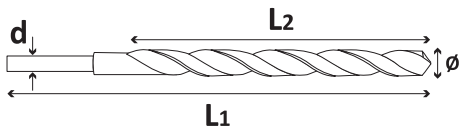





Item code	Size			Pcs. per box
	Ø	L2	L1	
EM 01 00 200	2	56	85	10
EM 01 00 250	2,5	62	95	10
EM 01 00 300	3	66	100	10
EM 01 00 350	3,5	73	112	10
EM 01 00 400	4	78	119	10
EM 01 00 425	4,25	78	119	10
EM 01 00 450	4,5	82	126	10
EM 01 00 475	4,75	82	126	10
EM 01 00 500	5	87	132	10
EM 01 00 525	5,25	87	132	10
EM 01 00 550	5,5	91	139	10
EM 01 00 575	5,75	91	139	10
EM 01 00 600	6	91	139	10
EM 01 00 625	6,25	97	148	10
EM 01 00 650	6,5	97	148	10
EM 01 00 700	7	102	156	10
EM 01 00 750	7,5	102	156	10
EM 01 00 800	8	109	165	10
EM 01 00 850	8,5	109	165	10
EM 01 00 900	9	115	175	5
EM 01 00 950	9,5	115	175	5
EM 01 01 000	10	121	184	5
EM 01 01 050	10,5	121	184	5
EM 01 01 100	11	18	195	5
EM 01 01 150	11,5	128	195	5
EM 01 01 200	12	134	205	5
EM 01 01 300	13	134	205	5

Box / Boîte / Verpackung / Caja / Упаковка



EP 01

-  **DIN 338 N - HSSCO (M35) cobalt straight shank twist drill for metals, fully ground from the solid, split point 135°, amber finishing**
-  **DIN 338 N - Foret hélicoïdal HSSCO (M35) mèche à queue cylindrique, recoltée du plein, ambré**
-  **DIN 338 N - Bernstein gefarbte HSSCO (M35) Spiralbohrer mit Zylinderschaft, aus dem Vollen geschliffen**
-  **DIN 338 N - HSSCO (M35) broca cobalto helicoidal con mango cilíndrico para metal, obtenida de la pieza entera, acabado ámbar**
-  **DIN 338 тип N - HSSCO (M35) кобальтовое сверло по металлу из цельного материала, цилиндрический хвостовик, угол заточки 135°, золотисто-коричневое покрытие**

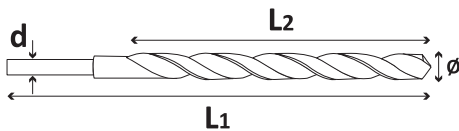
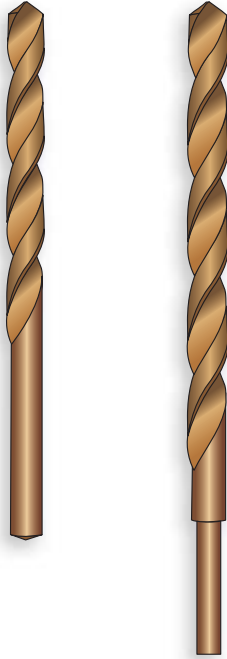

Item code	Size			Pcs. per box
	Ø	L2	L1	
EP 01 00 100	1	12	34	10
EP 01 00 150	1,5	18	40	10
EP 01 00 200	2	24	49	10
EP 01 00 250	2,5	30	57	10
EP 01 00 300	3	33	61	10
EP 01 00 350	3,5	39	70	10
EP 01 00 400	4	43	75	10
EP 01 00 450	4,5	47	80	10
EP 01 00 500	5	47	80	10
EP 01 00 550	5,5	57	93	10
EP 01 00 600	6	57	93	10
EP 01 00 650	6,5	63	101	10
EP 01 00 700	7	69	109	10
EP 01 00 750	7,5	69	109	10
EP 01 00 800	8	75	117	10
EP 01 00 850	8,5	75	117	5
EP 01 00 900	9	81	125	5
EP 01 00 950	9,5	81	125	5
EP 01 01 000	10	87	133	5
EP 01 01 050	10,5	87	133	5
EP 01 01 100	11	94	142	5
EP 01 01 150	11,5	94	142	5
EP 01 01 200	12	101	151	5
EP 01 01 300	13	101	151	5

Box / Boîte / Verpackung / Caja / Упаковка



GQ 01

 **DIN 18 97 - HSS straight shank twist drill stub series (extra short series) for tinsmiths, bright finishing**

 DIN 1897 - Foret hélicoïdal HSS mèche à queue cylindrique, extra courte, finition polie

 DIN 1897 - Extra kurzer HSS Spiralbohrer mit Zylinderschaft, blanke Ausführung

 DIN 1897 - HSS broca helicoidal con mango cilíndrico, acabado brillante, serie extracorta

 DIN 18 97 - HSS сверло по металлу шлифованное, цилиндрический хвостовик, сверхкороткая серия

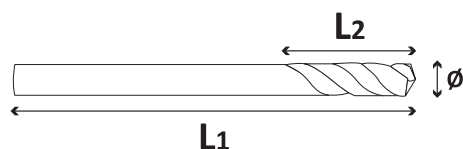





Item code	Size			Pcs. per box
	Ø	L2	L1	
GQ 01 00 250	2,5	14	43	10
GQ 01 00 300	3	16	46	10
GQ 01 00 325	3,25	18	49	10
GQ 01 00 350	3,5	20	52	10
GQ 01 00 375	3,75	22	55	10
GQ 01 00 400	4	22	55	10
GQ 01 00 450	4,5	24	58	10
GQ 01 00 500	5	26	62	10
GQ 01 00 550	5,5	28	66	10
GQ 01 00 600	6	28	66	10
GQ 01 00 650	6,5	31	70	10
GQ 01 00 700	7	34	74	10
GQ 01 00 800	8	37	79	10

Box / Boîte / Verpackung / Caja / Упаковка



ES 01

-  **EURONORM DIN 8039 - tungsten carbide tipped masonry twist drill, right screw, zinc plated, one piece per pouch with blister hole**
-  **EURONORM DIN 8039 - foret hélicoïdal mèche à queue cylindrique pour murs, hélice droite, zinguée, un pièce par blister**
-  **EURONORM DIN 8039 - Verzinkter Spiralbohrer mit Zylinderschaft, rechtsschneidend, für Mauerwerke, ein Stück per Blister**
-  **EURONORM DIN 8039 - broca helicoidal con mango cilíndrico, plaquita de carburo de tungsteno, para hormigón, cincada, 1 unidad en cada bolsa**
-  **EURONORM DIN 8039 - оцинкованное сверло по бетону с твердосплавным наконечником, цилиндрический хвостовик, праворежущее, упаковка - 1 шт. в мешочке с отверстием**

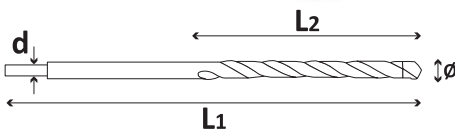
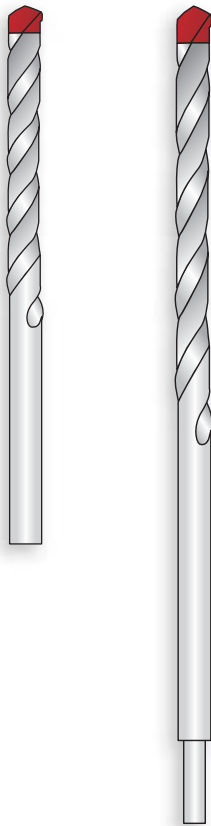

Box / Boîte / Verpackung / Caja / Упаковка



Item code	Size				Pcs. per box
	Ø	L1	L2	d	
ES 01 03 065	3	65	40	2,5	1
ES 01 04 075	4	75	40	3,2	1
ES 01 05 085	5	85	40	4	1
ES 01 06 100	6	100	55	4,8	1
ES 01 07 100	7	100	55	5,5	1
ES 01 08 120	8	120	70	6,2	1
ES 01 09 120	9	120	70	7	1
ES 01 10 120	10	120	70	7,5	1
ES 01 11 150	11	150	90	8,5	1
ES 01 12 150	12	150	90	8,5	1
ES 01 13 150	13	150	90	10	1
ES 01 14 150	14	150	90	10	1
ES 01 15 150	15	150	90	10	1
ES 01 16 150	16	150	90	10	1
ES 01 17 150	17	150	90	10	1
ES 01 18 160	18	160	100	13	1
ES 01 20 160	20	160	100	13	1
ES 01 22 160	22	160	100	13	1
ES 01 24 160	24	160	100	13	1
ES 01 25 160	25	160	100	13	1
ES 01 06 200	6	200	115	4,8	1
ES 01 08 200	8	200	115	6,2	1
ES 01 10 200	10	200	115	7,5	1
ES 01 12 200	12	200	120	8,5	1
ES 01 14 200	14	200	120	10	1
ES 01 06 400	6	400	240	4,8	1
ES 01 08 400	8	400	240	6,2	1
ES 01 10 400	10	400	240	7,5	1
ES 01 12 400	12	400	240	8,5	1
ES 01 14 400	14	400	240	10	1
ES 01 16 400	16	400	240	13	1
ES 01 18 400	18	400	240	13	1
ES 01 20 400	20	400	240	13	1
ES 01 22 400	22	400	240	13	1
ES 01 24 400	24	400	250	13	1
ES 01 25 400	25	400	250	13	1
ES 01 26 400	26	400	250	13	1
ES 01 06 600	6	600	370	4,8	1
ES 01 08 600	8	600	370	6,2	1
ES 01 10 600	10	600	370	7,5	1
ES 01 12 600	12	600	370	8,5	1
ES 01 14 600	14	600	370	10	1
ES 01 16 600	16	600	370	13	1
ES 01 18 600	18	600	370	13	1
ES 01 20 600	20	600	370	13	1
ES 01 22 600	22	600	370	13	1
ES 01 24 600	24	600	370	13	1
ES 01 25 600	25	600	370	13	1
ES 01 26 600	26	600	370	13	1
ES 01 28 600	28	600	370	13	1
ES 01 30 600	30	600	370	13	1

EN 01

 **DIN 8039 - tungsten carbide tipped masonry twist drill, milled flutes, for rotary and roto-percussion drilling, one piece in one plastic tube with blister hole**

 DIN 8039 - foret hélicoïdal mèche à queue cylindrique, hélice droite meulée, un pièce par blister

 DIN 8039 - Geschliffener Spiralbohrer, mit Zylinderschaft, rechtsschneidend geschliffen, ein Stück per Blister

 DIN 8039 - broca helicoidal con mango cilíndrico, plaquita de carburo de tungsteno, para hormigón, para trabajo en roto-percusión, 1 unidad en cada tubo de plástico

 DIN 8039 - сверло по бетону с твердoplавным наконечником для обычных и ударных дрелей, цилиндрический хвостовик, упаковка - 1 шт в пластиковой трубе с отверстием



Item code	Size				Pcs. per box
	∅	L1	L2	d	
EN 01 04 075	4	75	40	3,5	1
EN 01 05 085	5	85	40	4	1
EN 01 06 100	6	100	55	5	1
EN 01 06 200	6	200	115	5	1
EN 01 07 100	7	100	55	6	1
EN 01 08 120	8	120	70	7	1
EN 01 08 200	8	200	115	7	1
EN 01 09 120	9	120	70	8	1
EN 01 10 120	10	120	70	9	1
EN 01 10 250	10	250	120	9	1
EN 01 11 150	11	150	90	10	1
EN 01 12 150	12	150	90	10	1
EN 01 12 250	12	250	120	10	1
EN 01 13 150	13	150	90	10	1
EN 01 14 150	14	150	90	10	1
EN 01 15 150	15	150	90	10	1
EN 01 16 150	16	150	90	13	1
EN 01 18 160	18	160	100	13	1
EN 01 20 160	20	160	100	13	1
EN 01 22 160	22	160	100	13	1
EN 01 24 160	24	160	100	13	1
EN 01 25 160	25	160	100	13	1

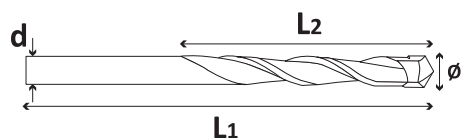

Box / Boîte / Verpackung / Caja / Упаковка



ER 01

-  **DIN 8039 - industrial grade tungsten carbide tipped masonry twist drill, ground flutes, polished with black groove, for rotary and roto-percussion drilling in concrete, very hard stone, granite, one piece in one hard plastic box with blister hole**
-  **DIN 8039 - foret hélicoïdal mèche à queue cylindrique avec plaquette spéciale pour performances élevées, un pièce par blister**
-  **DIN 8039 - Spiralbohrer mit Zylinderschaft, mit Spezialeinsatz für Hochleistungen, ein Stück per Blister**
-  **DIN 8039 - broca helicoidal con mango cilíndrico, plaquita de carburo de tungsteno, para altas prestaciones en trabajo en roto-percusión sobre hormigón, piedra maciza y granito, acabado brillante con hélice negra, 1 unidad en cada tubo de plástico**
-  **DIN 8039 - высококачественное прочное сверло по бетону с твердоплавным наконечником для обычных и ударных дрелей для сверления в бетоне, камне и граните, цилиндрический хвостовик, полированная поверхность с черными пазами, упаковка - 1 шт в пластиковой коробке с отверстием.**



Item code	Size				Pcs. per box
	∅	L1	L2	d	
ER 01 03 060	3	65	35	2,5	1
ER 01 04 075	4	75	40	3,5	1
ER 01 05 085	5	85	40	4	1
ER 01 06 100	6	100	55	5	1
ER 01 06 200	6	200	115	5	1
ER 01 07 100	7	100	55	6	1
ER 01 08 120	8	120	70	7	1
ER 01 08 200	8	200	115	7	1
ER 01 09 120	9	120	70	8	1
ER 01 10 120	10	120	70	9	1
ER 01 10 200	10	200	115	9	1
ER 01 11 150	11	150	90	10	1
ER 01 12 150	12	150	90	10	1
ER 01 12 200	12	200	120	10	1
ER 01 13 150	13	150	90	10	1
ER 01 14 150	14	150	90	10	1
ER 01 16 150	16	150	90	13	1
ER 01 17 160	17	160	90	13	1
ER 01 18 160	18	160	100	13	1
ER 01 20 160	20	160	100	13	1
ER 01 22 160	22	160	100	13	1
ER 01 24 160	24	160	100	13	1
ER 01 25 160	25	160	100	13	1

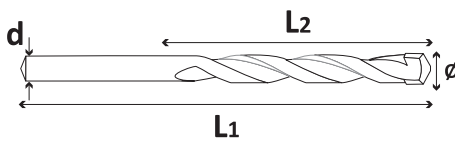

Box / Boîte / Verpackung / Caja / Упаковка



EO 01

 **Tungsten carbide tipped twist drills, shank type SDS-PLUS, ground flutes, sandblasted finishing, one piece in one plastic tube with blister hole**

 Foret hélicoïdal pour marteau perforateur à queue SDS-PLUS, un pièce par blister

 Spiralhammerbohrer, Schaft SDS-PLUS, ein Stück per Blister

 Broca helicoidal con mango SDS-PLUS, plaquita de carburo de tungsteno, acabado arena, 1 unidad en cada clip de plástico

 Сверло с хвостовиком SDS-PLUS для перфоратора, матовое покрытие, упаковка - 1 шт в пластиковой тубе с отверстием

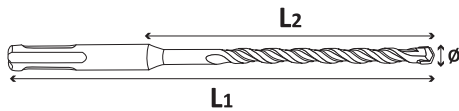

Box / Boîte / Verpackung / Caja / Упаковка



Item code	Size			Pcs. per box
	Ø	L2	L1	
EO 01 05 110	5	50	110	1
EO 01 06 110	6	50	110	1
EO 01 07 110	7	50	110	1
EO 01 08 110	8	50	110	1
EO 01 10 110	10	50	110	1
EO 01 05 160	5	100	160	1
EO 01 06 160	6	100	160	1
EO 01 07 160	7	100	160	1
EO 01 08 160	8	100	160	1
EO 01 09 160	9	100	160	1
EO 01 10 160	10	100	160	1
EO 01 12 160	12	100	160	1
EO 01 14 160	14	100	160	1
EO 01 15 160	15	100	160	1
EO 01 16 160	16	100	160	1
EO 01 05 210	5	150	210	1
EO 01 55 210	5,5	150	210	1
EO 01 06 210	6	150	210	1
EO 01 08 210	8	150	210	1
EO 01 09 210	9	150	210	1
EO 01 10 210	10	150	210	1
EO 01 12 210	12	150	210	1
EO 01 14 210	14	150	210	1
EO 01 16 210	16	150	210	1
EO 01 18 210	18	150	210	1
EO 01 20 210	20	150	210	1
EO 01 24 210	24	160	210	1
EO 01 25 210	25	160	210	1
EO 01 06 260	6	200	260	1
EO 01 08 260	8	200	260	1
EO 01 10 260	10	200	260	1
EO 01 12 260	12	200	260	1
EO 01 14 260	14	200	260	1
EO 01 16 260	16	200	260	1
EO 01 18 260	18	200	260	1
EO 01 20 260	20	200	260	1
EO 01 22 260	22	200	260	1
EO 01 24 260	24	200	260	1
EO 01 25 260	25	200	260	1
EO 01 05 310	5	250	310	1
EO 01 55 310	5,5	250	310	1
EO 01 05 360	5	300	360	1
EO 01 55 360	5,5	300	360	1
EO 01 10 450	10	400	450	1
EO 01 12 450	12	400	450	1
EO 01 14 450	14	400	450	1
EO 01 16 450	16	400	450	1
EO 01 18 450	18	400	450	1
EO 01 20 450	20	400	450	1
EO 01 22 450	22	400	450	1
EO 01 24 450	24	400	450	1
EO 01 25 450	25	400	450	1
EO 01 26 450	26	400	450	1
EO 01 12 600	12	550	600	1
EO 01 14 600	14	550	600	1
EO 01 16 600	16	550	600	1
EO 01 18 600	18	550	600	1
EO 01 20 600	20	550	600	1
EO 01 22 600	22	550	600	1

EZ 01

🇮🇹 Until stockout
🇫🇷 Jusqu'à épuisement des stocks
🇩🇪 Solange der Vorrat reicht
🇪🇸 Hasta agotar existencias
🇷🇺 до окончания стока

Assortment in metal box of DIN 338 N - HSS straight shank twist drill for metals, rollforged right screw, black finishing short series

- 🇫🇷 Assortiment dans boîte de métal de DIN 338 N - HSS foret hélicoïdal à queue cylindrique, finition noire, série courte
- 🇩🇪 Sortiment in Metallverpackung von DIN 338N - HSS Schwarzer gerollter Spiralbohrer mit Zylinderschaft, kurze Ausführung
- 🇪🇸 Surtido de DIN 338 N - HSS, brocas helicoidales con mango cilíndrico para metal, redobladas, acabado negro, serie corta, en caja de metal
- 🇷🇺 Набор сверл DIN 338 тип N - HSS по металлу с роликовой прокаткой, цилиндрический хвостовик, черное покрытие, короткая серия, в металлической коробке



Item code	Pcs. per Box	Pcs. per carton
EZ 01 00 013	13	1
EZ 01 00 019	19	1

FC 01

🇮🇹 Until stockout
🇫🇷 Jusqu'à épuisement des stocks
🇩🇪 Solange der Vorrat reicht
🇪🇸 Hasta agotar existencias
🇷🇺 до окончания стока

Assortment in plastic squared box of drills, bits and plug (cheap type)

- 🇫🇷 Assortiment dans boîte de plastique de forets, embouts et chevilles (type économique)
- 🇩🇪 Sortiment in Plastikverpackung von Bohrer, Bit und Dübel (billige Art)
- 🇪🇸 Surtido de brocas, puntas y tacos (tipo barato), en caja de plástico
- 🇷🇺 Набор сверл, битов и дюбелей (экономичная модель) в пластиковой коробке



Item code	Pcs. per Box	Pcs. per carton
FC 01 00 300	300	1

FA 01

🇮🇹 Until stockout
🇫🇷 Jusqu'à épuisement des stocks
🇩🇪 Solange der Vorrat reicht
🇪🇸 Hasta agotar existencias
🇷🇺 до окончания стока

Assortment in plastic round box of DIN 338 N - HSS straight shank twist drill for metals, rollforged right screw, black finishing short series





- 🇫🇷 Assortiment dans boîte de métal de DIN 338 N - foret hélicoïdal HSS mèche à queue cylindrique, recoltée du plein, polie, série courte
- 🇩🇪 Sortiment in Metallverpackung von DIN 338 N - Blanker HSS Spiralbohrer mit Zylinderschaft, aus dem Vollen geschliffen, kurze Ausführung
- 🇪🇸 Surtido de DIN 338 N - HSS, brocas helicoidales con mango cilíndrico para metal, redobladas, acabado negro, serie corta, en cilindro de plástico
- 🇷🇺 Набор сверл по металлу DIN 338 тип N - HSS с роликовой прокаткой, цилиндрический хвостовик, черное покрытие, короткая серия, в круглой пластиковой упаковке



Item code	Pcs. per Box	Pcs. per carton
FA 01 00 013	13	1
FA 01 00 019	19	1

JJ 01

HIGH PERFORMANCE magnetic bit holder, 1/4" hex shank

-  Douille magnétique haute performances pour visseuses, queue hexagonale 1/4"
-  Hochleistungs- magnetischer Bits-Halter für Schrauber, 1/4" Sechskantschaft
-  Portapuntas magnético para ALTAS PRESTACIONES, mango hexagonal 1/4"
-  Высокоэффективный магнитный держатель бит, шестигранный хвостовик 1/4"



Bit Holder





Item Code	Shank size	Bit length (mm)	Pcs. per box	Pcs. per carton
JJ 01 14 060	1/4"	60	1	12
JJ 01 14 075	1/4"	75	1	12

Box / Boîte / Verpackung / Caja / Упаковка



FO 01

Magnetic bit holder 1/4" hex shank

-  Douille magnétique pour visseuses, queue hexagonale 1/4"
-  Magnetischer Bits-Halter für Schrauber, 1/4" Sechskantschaft
-  Portapuntas magnético, mango hexagonal 1/4"
-  Магнитный держатель бит, шестигранный хвостовик 1/4"



Bit Holder





Item Code	Shank size	Bit length (mm)	Pcs. per box
FO 01 14 060	1/4"	60	12
FO 01 14 075	1/4"	75	12

Box / Boîte / Verpackung / Caja / Упаковка



FK 01

Cross type H power bit, 1/4" hex shank, sandblasted finishing

-  Embouts de vissage cruciforme Type H, queue hexagonale 1/4", finition sablée
-  Kreuzschlitz H-Bit für Schrauber, mit 1/4"-Sechskantschaft, Mattbehandlung
-  Punta de atornillar Cruz tipo H, mango hexagonal 1/4", acabado arena
-  Крестообразный бит типа H, шестигранный хвостовик 1/4", матовое покрытие

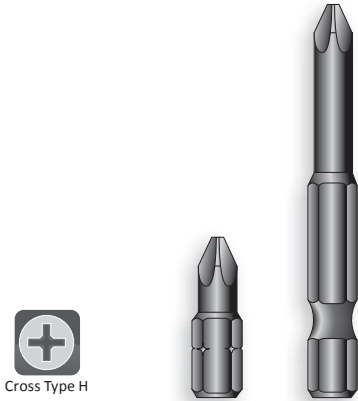





Item Code	Size	Bit length (mm)	Pcs. per box
short series			
FK 01 00 025	0	25	25
FK 01 01 025	1	25	25
FK 01 02 025	2	25	25
FK 01 03 025	3	25	25
long series			
FK 01 01 050	1	50	20
FK 01 02 050	2	50	20
FK 01 03 050	3	50	20

Box / Boîte / Verpackung / Caja / Упаковка



FN 01

In-hex power bit, 1/4" hex shank, sandblasted finishing, fitting hex recess head screws

-  Embouts de vissage à six pans creux, queue hexagonale 1/4", finition sablée
-  Innensechskantbit für Schrauber, mit 1/4"-Sechskantschaft, Mattbehandlung
-  Punta de atornillar para huellas hexagonales, mango hexagonal 1/4", acabado arena
-  Бит для шурупов с внутренним шестигранником, шестигранный хвостовик 1/4", матовое покрытие

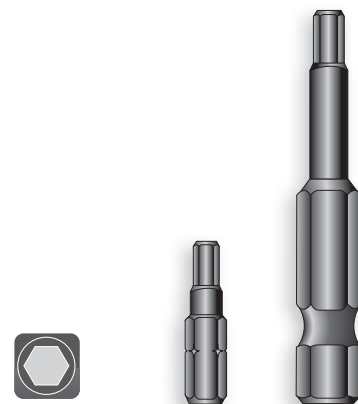





Item Code	AF size (mm)	Bit length (mm)	Pcs. per box
short series			
FN 01 02 025	2	25	25
FN 01 03 025	3	25	25
FN 01 04 025	4	25	25
FN 01 05 025	5	25	25
FN 01 06 025	6	25	25
long series			
FN 01 02 050	2	50	20
FN 01 03 050	3	50	20
FN 01 04 050	4	50	20
FN 01 05 050	5	50	20
FN 01 06 050	6	50	20

Box / Boîte / Verpackung / Caja / Упаковка



Tools and accessories / Outils et accessoires / Werkzeuge und Zubehör / Brocas y Herramientas / Инструменты и аксессуары

FL 01

-  **Cross type Z power bit, 1/4" hex shank, sandblasted finishing**
-  Embouts de vissage cruciforme Type Z, queue hexagonale 1/4" , finition sablée
-  Kreuzschlitz Z-Bit für Schrauber, mit 1/4"-Sechskantschaft, Mattbehandlung
-  Punta de atornillar Cruz tipo Z, mango hexagonal 1/4", acabado arena
-  Крестообразный бит типа Z , шестигранный хвостовик 1/4", матовое покрытие

Item Code	Size	Bit length (mm)	Pcs. per box
<i>short series</i>			
FL 01 01 025	1	25	25
FL 01 02 025	2	25	25
FL 01 03 025	3	25	25
FL 01 04 025	4	25	25
<i>serie lunga</i>			
FL 01 01 050	1	50	20
FL 01 02 050	2	50	20
FL 01 03 050	3	50	20
FL 01 04 050	4	50	20





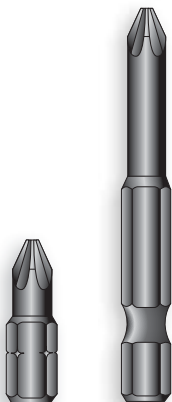

Cross Type Z



Box / Boîte / Verpackung / Caja / Упаковка



RG 01

-  **High Performance Cross recessed Type Z power bit, 1/4" hex shank, sandblasted finishing**
-  Embouts de vissage cruciforme Type Z pour haute performances, queue hexagonale 1/4", finition sablée
-  Hochleistungs-Kreuzschlitz Z-Bit für Schrauber, mit 1/4"-Sechskantschaft, Mattbehandlung
-  Punta de atornillar Cruz tipo Z para ALTAS PRESTACIONES, mango hexagonal 1/4", acabado arena
-  Высокоэффективный крестообразный бит типа Z, шестигранный хвостовик 1/4", матовое покрытие

Item Code	Size	Bit length (mm)	Pcs. per box
<i>short series</i>			
RG 01 04 030	4	30	25
<i>long series</i>			
RG 01 04 050	4	50	20



Cross Type Z

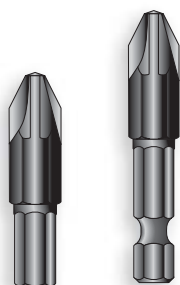





Box / Boîte / Verpackung / Caja / Упаковка



FM 01

6-lobe power bits, 1/4" hex shank, sandblasted finishing

-  Embouts de vissage six lobe, queue hexagonale 1/4" , finition sablée
-  Innensechskantbit für Schrauber, mit 1/4"-Sechskantschaft, Mattbehandlung
-  Punta de atornillar 6 lóbulos internos, mango hexagonal 1/4", acabado arena
-  Шестигранный бит, шестигранный хвостовик 1/4", матовое покрытие

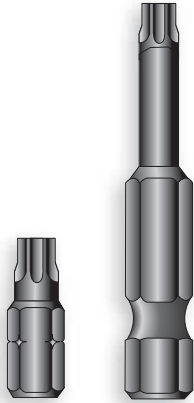





Item Code	Size	Bit length (mm)	Pcs. per box
<i>short series</i>			
FM 01 10 025	10	25	25
FM 01 15 025	15	25	25
FM 01 20 025	20	25	25
FM 01 25 025	25	25	25
FM 01 30 025	30	25	25
FM 01 40 025	40	25	25
FM 01 50 030	50	30	20
<i>long series</i>			
FM 01 30 050	30	50	20
FM 01 40 050	40	50	20
FM 01 50 050	50	50	20

Box / Boîte / Verpackung / Caja / Упаковка



JB 01

HIGH PERFORMANCE 6-lobe power bit, 1/4" hex shank, sandblasted finishing

-  Embouts de vissage haute performances six lobe, queue hexagonale 1/4" , finition sablée
-  Hochleistungs- Innensechskantbit für Schrauber, mit 1/4"-Sechskantschaft, Mattbehandlung
-  Punta de atornillar 6 lóbulos internos para ALTAS PRESTACIONES, mango hexagonal 1/4", acabado arena
-  Высокоэффективный бит для шурупов с шестигранной головкой, шестигранный хвостовик 1/4", матовое покрытие

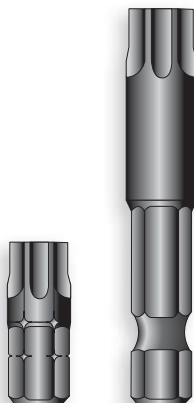

Item Code	Size	Bit length (mm)	Pcs. per box
<i>short series</i>			
JB 01 40 025	40	25	20
<i>long series</i>			
JB 01 40 050	40	50	20

Box / Boîte / Verpackung / Caja / Упаковка



FP 01

 **Magnetic nutsetter, 1/4" hex shank, sandblasted finishing, in small carton box**

 Capote magnétique hexagonale 1/4", finition sablée

 Magnetischer Sechskant- Steckeinschlüsseinsatz, 1/4" Mattbehandlung

 Voca hexagonal magnética, mango hexagonal 1/4", acabado arena

 Магнитная насадка, шестигранный хвостовик 1/4", матовое покрытие, в картонной упаковке

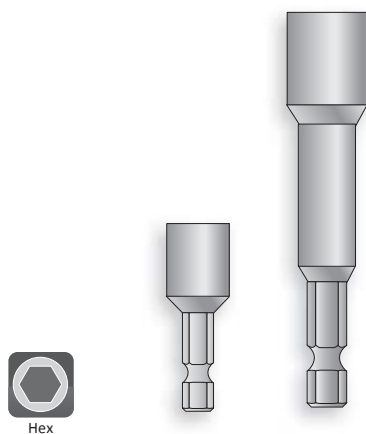

Item Code	Size (mm)	Bit length (mm)	Pcs. per box
<i>short series</i>			
FP 01 07 042	7	42	20
FP 01 08 045	8	45	10
FP 01 10 045	10	45	6
<i>long series</i>			
FP 01 07 065	7	65	12
FP 01 08 065	8	65	12
FP 01 10 065	10	65	12
FP 01 12 065	12	65	12
FP 01 13 065	13	65	12
FP 01 17 065	17	65	6
<i>extra long series</i>			
FP 01 10 235	10	235	5

Box / Boîte / Verpackung / Caja / Упаковка



JP 00

 **Non magnetic HIGH PERFORMANCE nutsetter, 1/4" hex shank, sandblasted finishing**

 Capote non-magnétique hexagonale pour haute performances 1/4", finition sablée

 Hochleistungs- Nichtmagnetischer Sechskant- Steckeinschlüsseinsatz, 1/4" Mattbehandlung

 Voca hexagonal no magnética para ALTAS PRESTACIONES, mango hexagonal 1/4", acabado arena

 Высокоэффективная немагнитная насадка, шестигранный хвостовик 1/4", матовое покрытие

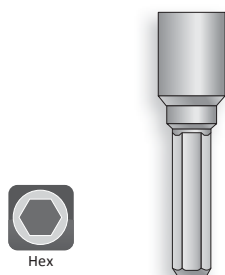





Item Code	Size (mm)	Bit length (mm)	Pcs. per box
JP 00 05 045	5	45	10
JP 00 07 045	7	45	10
JP 00 08 050	8	50	10

Box / Boîte / Verpackung / Caja / Упаковка



GC 01

-  **Ball adaptor for sockets 1/4" hex shank, sandblasted finishing**
-  Adapteur male avec sphère pour douille, queue hexagonale 1/4", finition sablée
-  Adapter mit Kugel für Steckeinschlüsseinsatz, 1/4" Sechskantschaft, Mattbehandlung
-  Adaptador con esfera para bocas, mango hexagonal 1/4", acabado arena
-  Адаптор, шестигранный хвостовик 1/4", матовое покрытие

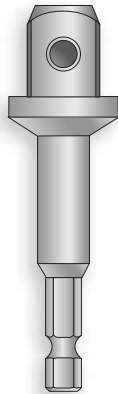





Item code	Size	Pcs. per box
	L (mm)	
GC 01 12 075	75	12

Box / Boîte / Verpackung / Caja / Упаковка





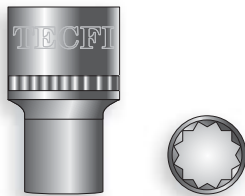

GD - GE

-  **12 points chrome vanadium socket, 1/2" female square, size 11**
-  Capote polygonale (bi-hexagonale), clé 11, en acier au chrome, à emboîtement simple femelle 1/2"
-  Zwölfeckiger Steckschlüsseinsatz, Schlüssel 11, aus Chromstahl mit Rücksprung
-  Boca bihexagonal de cromo vanadio, conexión hembra 1/2", llave 11
-  Полигональная насадка, размер 11, втулка 1/2"



Item code	Size	Pcs. per box
	AF x L (mm)	
GD 01 11 038	11 x 38	10

-  **Hex socket chrome vanadium, 1/2" female square, AF 10 and AF 19**
-  Capote hexagonale en acier au chrome, à emboîtement simple femelle 1/2"
-  Sechskanter Steckschlüsseinsatz, aus Chromstahl mit Rücksprung
-  Boca hexagonal de cromo vanadio, conexión hembra 1/2", llave 10 y llave 19
-  Шестигранная насадка, втулка 1/2", под шестигранный ключ 10

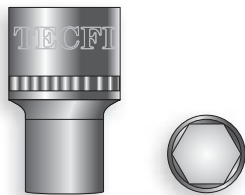

Item code	Size	Pcs. per box
	AF x L (mm)	
GE 01 10 038	10 x 38	10
GE 01 19 038	19 x 38	10





Box / Boîte / Verpackung / Caja / Упаковка



GY 01

Screwy®

Screwy® - Bits set, to be used as hand screwdriver or with power tool

-  Screwy® - Série de embouts de vissage avec kit tournevis
-  Screwy® - Bit Serie mit Schraubenzieher-Kit
-  Screwy® - Surtido de puntas de atornillar de utilizar como destornillador o con atornillador
-  Screwy® - Набор битов для ручного и электрического использования



Item code	Number of bits	Pcs. per box
GY 01 00 011	10	1



Pic. 1



Pic. 2

Usage / Utilisation / Benutzung / Uso / Применение



Box / Boîte / Verpackung / Caja / Упаковка



Bit holder (1 pc.)



Cross type H short series (3 pcs.)
1 x 25 - 2 x 25 - 3 x 25



Cross type Z short series (3 pcs.)
1 x 25 - 2 x 25 - 3 x 25



6-lobe short series (3 pcs.)
T15 - T20 - T25



Slotted short series (1 pc.)
1 x 5,5