



EasyBox - SE range, in plastic box

396



EasyBox - VZ-Handyplug® range, in ClipBox

397



CuboBox - VZ-Handyplug® range, in PET box

398



ExpoBox - VZ-Handyplug® range, in PET box

399

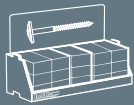

ExpoBox - Gutter/Tinsmith fixing range, in box

400

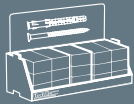

ExpoBox - VS-Handyplug® range, in box

404



Metallic stand

408

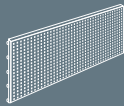

Accessories for metallic stand

410



Wall display stand

412



Brochures

413

 **T-Store® - Merchandising**

 T-Store® - Marchandisage

 T-Store® - Merchandising

 T-Store® - Merchandising

 T-Store® - Рекламная продукция

12

EasyBox



SE range Kit (nylon plugs)

Display unit for 18 boxes of SE range (for more details see page 210-211)



Item code	Contents	Size
		B x b (cm)
EXP 04 01 001	18 x SE 01	50 x 25
EXP 04 01 002	18 x SE 02	50 x 25
EXP 04 01 003	18 x SE 11	50 x 25
EXP 04 11 001	6 x SE 01 + 6 x SE 02 + 6 x SE 11	50 x 25

Description / Description / Beschreibung / Descripción / Описание
 Display unit including single item or assortment of SE01, SE02, SE11 (see page 214)



SE 01



SE 02



SE 11

EasyBox



ClipBox range Kit

“EasyBox” display stand with 16 ClipBox with multi-purpose nylon anchor VZ-Handyplug® (for more details see page 202-203)

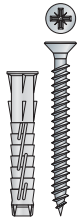

Item code	Contents	Pcs. per Clipbox Anchors + Screws	Anchor Size Ø x La (mm)	Screw Size Ø x Ls (mm)
Anchor size: Ø 6 mm				
VZXC xx* 06 032	16 clipbox	50 + 50	6 x 32	4,5 x 45
VZXC xx* 06 045	16 clipbox	40 + 40	6 x 45	4,5 x 55
Anchor size: Ø 8 mm				
VZXC xx* 08 042	16 clipbox	30 + 30	8 x 42	5 x 50
VZXC xx* 08 052	16 clipbox	25 + 25	8 x 52	5 x 60



*XX	Contents	Colours	
51	16 clipbox	Blue	
52	8 clipbox 8 clipbox	White Black	
53	8 clipbox 8 clipbox	Red Black	
54	8 clipbox 8 clipbox	Blue Black	
55	8 clipbox 8 clipbox	White Blue	
56	8 clipbox 8 clipbox	Yellow Red	
57	16 clipbox	Violet	
58	8 clipbox 8 clipbox	Red Blue	
59	8 clipbox 8 clipbox	Yellow Blue	
60	16 clipbox	Purple Red	
61	8 clipbox 8 clipbox	Pink Black	
62	8 clipbox 8 clipbox	Green Black	
63	8 clipbox 8 clipbox	White Red	
64	16 clipbox	Yellow	
99	16 clipbox	Assorted Colours	

CuboBox



VZ-Handyplug® in PET box Kit

"CuboBox" display stand with 8 PET Boxes with multi-purpose nylon anchor VZ-Handyplug®

Ø 6 mm



Item code	Contents	Anchor Size	Screw Size
		Ø x La (mm)	Ø x Ls (mm)
VZCB 02 06 032	VZB 02 06 032 - 8 PET boxes	6 x 32	4,5 x 45
VZCB 02 06 045	VZB 02 06 045 - 8 PET boxes	6 x 45	4,5 x 55

Ø 8 mm



Item code	Contents	Anchor Size	Screw Size
		Ø x La (mm)	Ø x Ls (mm)
VZCB 02 08 042	VZB 02 08 042 - 8 PET boxes	8 x 42	5 x 50
VZCB 02 08 052	VZB 02 08 052 - 8 PET boxes	8 x 52	5 x 60

ExpoBox

Handyplug
THE FACTORY PLUG



T-Store® - Merchandising



VZ-Handyplug® in PET box Kit

“ExpoBox” display stand with 16 PET Boxes with multi-purpose nylon anchor VZ-Handyplug®

KIT VZB VZ-Handyplug® multi-purpose nylon anchors assortment in ExpoBox



Item code	Contents	Anchor Size	Screw Size
		Ø x La (mm)	Ø x Ls (mm)
KIT VZB 02 001	VZB 02 06 032 - 4 PET boxes	6 x 32	4,5 x 45
	VZB 02 06 045 - 4 PET boxes	6 x 45	4,5 x 55
	VZB 02 08 042 - 4 PET boxes	8 x 42	5 x 50
	VZB 02 08 052 - 4 PET boxes	8 x 52	5 x 60
KIT VZB 02 002	VZB 02 06 032 - 8 PET boxes	6 x 32	4,5 x 45
	VZB 02 08 042 - 8 PET boxes	8 x 42	5 x 50
KIT VZB 02 003	VZB 02 06 045 - 8 PET boxes	6 x 45	4,5 x 55
	VZB 02 08 052 - 8 PET boxes	8 x 52	5 x 60

TOT

“ExpoBox” stand



Item Code	Size	Pcs. per box
	L x l x h (mm)	
TOT 01 07 001*	760 x 300 x 800	1

- * For every two Kits purchased, one free stand
- 🇫🇷 gratuit avec l'achat de 2 KIT (avec le présentoir "ExpoBox")
- 🇩🇪 Kostenlos bei Erwerb 2 KIT (mit "ExpoBox" Verkaufsständer)
- 🇪🇸 * de regalo con la compra de 2 Kit (completos de expositores "ExpoBox")
- 🇷🇺 * Бесплатно при покупке 2х комплектов (с настольным дисплеем "ExpoBox")





ExpoBox







Gutter/Tinsmith fixing Kit

"ExpoBox" display stand with 15 Boxes with gutter/tinsmith fixing screws

KIT LT NK 001





-  Assortment of A2 SS raised CSK wood screws with M-type EPDM/SS bonded washer (Item code NK)
-  Assortiment vis à bois et rondelle (art. NK), en acier INOX A2
-  Sortiment von Holzschrauben (Art. NK) mit Scheibe, aus EDELSTAHL A2
-  Surtido tornillos para madera con arandela, de Acero INOXIDABLE A2 (código NK)
-  Шурупы по дереву (код NK) из нержавеющей стали A2 в assortименте







-  A2 Stainless Steel
-  Acier inox A2
-  Edelstahl A2
-  Acero Inoxidable A2
-  Нержавеющая сталь A2

Item code	ExpoBox dimensions			
	B x b x h (mm)			
KIT LT NK 001	750 x 300 x 250			
Kit of:	Screw size Ø x Ls (mm)	Pcs. per box	Boxes	Total pcs.
NK 15 45 025	4,5 x 25	200	2	400
NK 15 45 035	4,5 x 35	200	2	400
NK 15 45 045	4,5 x 45	200	2	400
NK 20 45 025	4,5 x 25	200	2	400
NK 20 45 035	4,5 x 35	200	2	400
NK 20 45 045	4,5 x 45	200	2	400
NK 20 45 060	4,5 x 60	200	1	200
NK 20 45 080	4,5 x 80	200	1	200
NK 20 45 100	4,5 x 100	200	1	200
Total pcs.:			3.000	

KIT LT NM 001

-  Assortment of copper plated A2 SS raised CSK wood screws with M-type EPDM/copper bonded washer (Item code NM)
-  Assortiment vis à bois et rondelle (art. NM), en acier INOX A2 - cuivrée
-  Sortiment von Holzschrauben (Art. NM) mit Scheibe, aus EDELSTAHL A2, verkupfert
-  Surtido tornillos para madera con arandela, de Acero INOXIDABLE A2 - cuprífero (código NM)
-  Шурупы по дереву (код NM) из нержавеющей стали A2 в assortименте



-  A2 Stainless Steel copper plated screw / copper washer
-  Vis en Acier inox A2 cuivrée / rondelle en cuivre
-  Schraube aus Edelstahl A2 verkupfert / Kupfer Scheibe
-  Tornillo de Acero Inoxidable A2 cuprífero / arandela de cobre
-  Шуруп из нержавеющей стали A2 / медная шайба

Item code	ExpoBox dimensions			
	B x b x h (mm)			
KIT LT NM 001	750 x 300 x 250			
Kit of:	Screw size Ø x Ls (mm)	Pcs. per box	Boxes	Total pcs.
NM 15 45 025	4,5 x 25	200	2	400
NM 15 45 035	4,5 x 35	200	2	400
NM 15 45 045	4,5 x 45	200	2	400
NM 20 45 025	4,5 x 25	200	2	400
NM 20 45 035	4,5 x 35	200	2	400
NM 20 45 045	4,5 x 45	200	2	400
NM 20 45 060	4,5 x 60	200	1	200
NM 20 45 080	4,5 x 80	200	1	200
NM 20 45 100	4,5 x 100	200	1	200
Total pcs.:			3.000	

ExpoBox



Gutter/Tinsmith fixing Kit

"ExpoBox" display stand with 15 Boxes with gutter/tinsmith fixing screws

KIT LT NP 001

- ✚ Assortment of RAL 9002 grey white painted head A2 SS raised CSK wood screws with M-type EPDM/painted SS bonded washer (Item code NP)
- 🇫🇷 Assortiment vis à bois et rondelle (art. NP), en acier INOX A2 - BLANC-GRIS - RAL 9002
- 🇩🇪 Sortiment von Holzschrauben (Art. NP) mit Scheibe, aus EDELSTAHL A2 RAL 9002 grauweiß lackiert
- 🇪🇸 Surtido tornillos para madera con arandela, de Acero INOXIDABLE A2 - blanco grisáceo RAL 9002 (código NP)
- 🇷🇺 Шурупы по дереву (код NP) из нержавеющей стали A2 в assortименте в серо-белый цвет - RAL 9002



Item code	ExpoBox dimensions			
	B x b x h (mm)			
KIT LT NP 001	750 x 300 x 250			
Kit of:	Screw size Ø x Ls (mm)	Pcs. per box	Boxes	Total pcs.
NP 20 45 025	4,5 x 25	200	4	800
NP 20 45 035	4,5 x 35	200	4	800
NP 20 45 045	4,5 x 45	200	4	800
NP 20 45 060	4,5 x 60	200	3	600
Total pcs.:				3.000



- 🇩🇪 **RAL 9002 grey white painted A2 Stainless Steel**
- 🇫🇷 Acier inox A2 laquée blanc-gris RAL 9002
- 🇩🇪 Edelstahl A2 RAL 9002 grauweiß lackiert
- 🇪🇸 Acero Inoxidable A2 barnizado blanco grisáceo RAL 9002
- 🇷🇺 Нержавеющая сталь A2, цвет серо-белый RAL 9002

KIT LT NQ 001

- ✚ Assortment of RAL 8017 chocolate brown painted head A2 SS raised CSK wood screws with M-type EPDM/painted SS bonded washer (Item code NQ)
- 🇫🇷 Assortiment vis à bois et rondelle (art. NQ), en acier INOX A2 - BRUN CHOCOLAT - RAL 8017
- 🇩🇪 Sortiment von Holzschrauben (Art. NQ) mit EDELSTAHL A2 RAL 8017 Schokoladenbraun lackiert
- 🇪🇸 Surtido tornillos para madera con arandela, de Acero INOXIDABLE A2 - marrón oscuro RAL 8017 (código NQ)
- 🇷🇺 Шурупы по дереву (код NQ) из нержавеющей стали A2 в assortименте в коричневый цвет RAL 8017

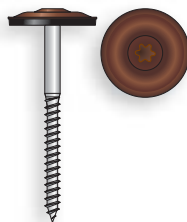

Item code	ExpoBox dimensions			
	B x b x h (mm)			
KIT LT NQ 001	750 x 300 x 250			
Kit of:	Screw size Ø x Ls (mm)	Pcs. per box	Boxes	Total pcs.
NQ 20 45 025	4,5 x 25	200	4	800
NQ 20 45 035	4,5 x 35	200	4	800
NQ 20 45 045	4,5 x 45	200	4	800
NQ 20 45 060	4,5 x 60	200	3	600
Total pcs.:				3.000



- 🇩🇪 **RAL 8017 chocolate brown A2 Stainless Steel**
- 🇫🇷 Acier inox A2 laquée brun chocolat RAL 8017
- 🇩🇪 Edelstahl A2 RAL 8017 Schokoladenbraun lackiert
- 🇪🇸 Acero Inoxidable A2 barnizado marrón oscuro RAL 8017
- 🇷🇺 Нержавеющая сталь A2, цвет Коричневый Шоколад, RAL 8017





ExpoBox



Gutter/Tinsmith fixing Kit

"ExpoBox" display stand with 15 Boxes with gutter/tinsmith fixing assorted screws

KIT LT 00 001

-  Assortment of A2 SS raised CSK wood screws with M-type EPDM bonded washer, in various finishing
-  Assortiment de vis à bois et rondelle en acier INOX A2 - PLUSIEURS FINITION
-  Sortiment von Holzschrauben mit Scheibe aus EDELSTAHL A2 - VERSCHIEDENE BEHANDLUNGEN
-  Surtido tornillos para madera con arandela, de Acero INOXIDABLE A2 - varios acabados
-  Шурупы по дереву из нержавеющей стали A2 в ассортименте в различных отделок







Item code	ExpoBox dimensions			
	B x b x h (mm)			
KIT LT 00 001	750 x 300 x 250			
Kit of:	Screw size Ø x Ls (mm)	Pcs. per box	Boxes	Total pcs.
A2 Stainless Steel				
NK 20 45 025	4,5 x 25	200	1	200
NK 20 45 035	4,5 x 35	200	1	200
NK 20 45 045	4,5 x 45	200	1	200
A2 Stainless Steel - Copper plated				
NM 20 45 025	4,5 x 25	200	1	200
NM 20 45 035	4,5 x 35	200	1	200
NM 20 45 045	4,5 x 45	200	1	200
NM 20 45 060	4,5 x 60	200	1	200
A2 Stainless Steel - RAL 9002 Grey white				
NP 20 45 025	4,5 x 25	200	1	200
NP 20 45 035	4,5 x 35	200	1	200
NP 20 45 045	4,5 x 45	200	1	200
NP 20 45 060	4,5 x 60	200	1	200
A2 Stainless Steel - RAL 8017 Chocolate brown				
NQ 20 45 025	4,5 x 25	200	1	200
NQ 20 45 035	4,5 x 35	200	1	200
NQ 20 45 045	4,5 x 45	200	1	200
NQ 20 45 060	4,5 x 60	200	1	200
Total pcs.:				3.000

TOT

"ExpoBox" floor stand



Item Code	Size	Pcs. per box
	L x l x h (mm)	
TOT 01 07 001*	760 x 300 x 800	1

-  * For every two Kits purchased, one stand free
-  * gratuit avec l'achat de 2 KIT (avec le présentoir "Expobox")
-  * Kostenlos bei Erwerb 2 KIT (mit "Expobox" Verkaufsständer)
-  * de regalo con la compra de 2 Kit (completos de expositores "Expobox")
-  * Бесплатно при покупке 2х комплектов (с настольным дисплеем "Expobox")

ExpoBox



Gutter/Tinsmith fixing Kit

"ExpoBox" display stand with 15 Boxes with gutter/tinsmith fixing assorted screws

KIT LT 00 002

- Assortment of nylon plug assembled with A2 SS raised CSK nail screws with M-type EPDM bonded washer, in various finishing
- Assortiment de vis avec rondelle et chevilles a marteler, en acier INOX A2 - PLUSIEURS FINITION
- Sortiment von Holzschrauben mit Scheibe und Nypondübel aus EDELSTAHL A2 - VERSCHIEDENE BEHANDLUNGEN
- Surtido tacos de nylon, montados con tornillos de golpe con arandela, de Acero INOXIDABLE A2 - varios acabados
- Assортимент дюбели и шурупы забивные из нержавеющей стали A2 в различных отделок

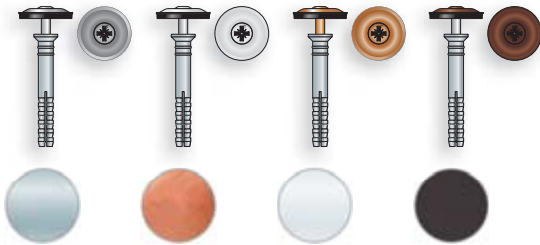

Item code	ExpoBox dimensions			
	B x b x h (mm)			
KIT LT 00 002	750 x 300 x 250			
Kit of:	Screw size Ø x Ls (mm)	Pcs. per box	Boxes	Total pcs.
A2 Stainless Steel				
NR 20 06 035	6 x 35	200	1	200
NR 20 06 055	6 x 55	100	2	200
A2 Stainless Steel - Copper plated				
NS 20 06 035	6 x 35	200	2	400
NS 20 06 055	6 x 55	100	2	200
A2 Stainless Steel - RAL 9002 Grey white				
NT 20 06 035	6 x 35	200	2	400
NT 20 06 055	6 x 55	100	2	200
A2 Stainless Steel - RAL 8017 Chocolate brown				
NU 20 06 035	6 x 35	200	2	400
NU 20 06 055	6 x 55	100	2	200
Total pcs.:				3.000

TOT

"ExpoBox" floor stand



Item Code	Size	Pcs. per box
	L x l x h (mm)	
TOT 01 07 001*	760 x 300 x 800	1

- * For every two Kits purchased, one stand free
- * gratuit avec l'achat de 2 KIT (avec le présentoir "Expobox")
- * Kostenlos bei Erwerb 2 KIT (mit "Expobox" Verkaufsständer)
- * de regalo con la compra de 2 Kit (completos de expositores "ExpoBox")
- * Бесплатно при покупке 2х комплектов (с настольным дисплеем "ExpoBox")

ExpoBox



VS-Handyplug® Kit

"ExpoBox" display stand with 15 Boxes of VS-Handyplug® universal anchors - \varnothing 8 mm

\varnothing 8 mm

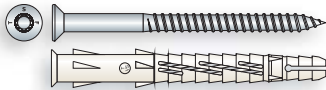

European Technical Approval
Use Category: a,b,c
ETA-13/0135 ETAG 020
DoP available on www.tecfi.it/DoP

Item code	"ExpoBox" dimensions			
	B x b x h (mm)			
KIT VS 11 002	750 x 300 x 250			

Kit of:	Anchor size $\varnothing \times L_a$ (mm)	Pcs. per box	Boxes	Total pcs.
VS 11 08 080	8 x 80	100	6	600
VS 11 08 100	8 x 100	100	3	300
VS 11 08 120	8 x 120	100	3	300
VS 11 08 140	8 x 140	50	3	150
Total pcs.:				1.350

\varnothing 8 mm

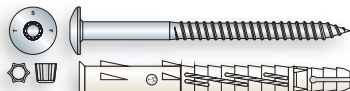

European Technical Approval
Use Category: a,b,c
ETA-13/0135 ETAG 020
DoP available on www.tecfi.it/DoP

Item code	"ExpoBox" dimensions			
	B x b x h (mm)			
KIT VS 21 002	750 x 300 x 250			

Kit of:	Anchor size $\varnothing \times L_a$ (mm)	Pcs. per box	Boxes	Total pcs.
VS 21 08 080	8 x 80	100	6	600
VS 21 08 100	8 x 100	100	3	300
VS 21 08 120	8 x 120	100	3	300
VS 21 08 140	8 x 140	50	3	150
Total pcs.:				1.350

\varnothing 8 mm

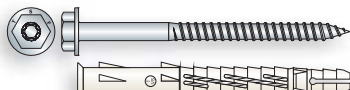

European Technical Approval
Use Category: a,b,c
ETA-13/0135 ETAG 020
DoP available on www.tecfi.it/DoP

Item code	"ExpoBox" dimensions			
	B x b x h (mm)			
KIT VS 31 002	750 x 300 x 250			

Kit of:	Anchor size $\varnothing \times L_a$ (mm)	Pcs. per box	Boxes	Total pcs.
VS 31 08 080	8 x 80	100	6	600
VS 31 08 100	8 x 100	100	3	300
VS 31 08 120	8 x 120	100	3	300
VS 31 08 140	8 x 140	50	3	150
Total pcs.:				1.350

\varnothing 8 mm

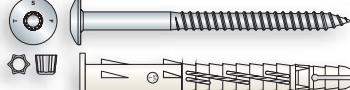

European Technical Approval
Use Category: a,b,c
ETA-13/0135 ETAG 020
DoP available on www.tecfi.it/DoP

Item code	"ExpoBox" dimensions			
	B x b x h (mm)			
KIT VS 71 002	750 x 300 x 250			

Kit of:	Anchor size $\varnothing \times L_a$ (mm)	Pcs. per box	Boxes	Total pcs.
VS 71 08 080	8 x 80	100	6	600
VS 71 08 100	8 x 100	100	3	300
VS 71 08 120	8 x 120	100	3	300
VS 71 08 140	8 x 140	50	3	150
Total pcs.:				1.350

\varnothing 8 mm

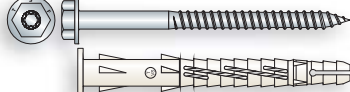

European Technical Approval
Use Category: a,b,c
ETA-13/0135 ETAG 020
DoP available on www.tecfi.it/DoP

Item code	"ExpoBox" dimensions			
	B x b x h (mm)			
KIT VS 81 002	750 x 300 x 250			

Kit of:	Anchor size $\varnothing \times L_a$ (mm)	Pcs. per box	Boxes	Total pcs.
VS 81 08 080	8 x 80	100	6	600
VS 81 08 100	8 x 100	100	3	300
VS 81 08 120	8 x 120	100	3	300
VS 81 08 140	8 x 140	50	3	150
Total pcs.:				1.350

ExpoBox



VS-Handyplug® Kit

"ExpoBox" display stand with 15 Boxes of VS-Handyplug® universal anchors - \varnothing 10 mm

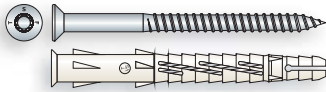
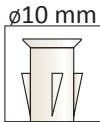

European Technical Approval
Use Category: a,b,c
ETA-13/0135 ETAG 020
DoP available on www.tecni.it/DoP

Item code	"ExpoBox" dimensions			
	B x b x h (mm)			
KIT VS 11 001	750 x 300 x 250			
<i>Kit of:</i>	<i>Anchor size</i> $\varnothing \times La$ (mm)	<i>Pcs. per box</i>	<i>Boxes</i>	<i>Total pcs.</i>
VS 11 10 080	10 x 80	50	3	150
VS 11 10 100	10 x 100	50	3	150
VS 11 10 120	10 x 120	50	3	150
VS 11 10 140	10 x 140	50	2	100
VS 11 10 160	10 x 160	50	2	100
VS 11 10 200	10 x 200	50	2	100
Total pcs.:				750

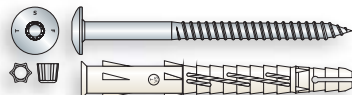
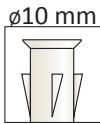

European Technical Approval
Use Category: a,b,c
ETA-13/0135 ETAG 020
DoP available on www.tecni.it/DoP

Item code	"ExpoBox" dimensions			
	B x b x h (mm)			
KIT VS 21 001	750 x 300 x 250			
<i>Kit of:</i>	<i>Anchor size</i> $\varnothing \times La$ (mm)	<i>Pcs. per box</i>	<i>Boxes</i>	<i>Total pcs.</i>
VS 21 10 080	10 x 80	50	3	150
VS 21 10 100	10 x 100	50	3	150
VS 21 10 120	10 x 120	50	3	150
VS 21 10 140	10 x 140	25	2	50
VS 21 10 160	10 x 160	25	2	50
VS 21 10 200	10 x 200	25	2	50
Total pcs.:				600

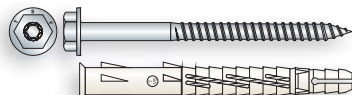
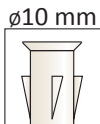

European Technical Approval
Use Category: a,b,c
ETA-13/0135 ETAG 020
DoP available on www.tecni.it/DoP

Item code	"ExpoBox" dimensions			
	B x b x h (mm)			
KIT VS 31 001	750 x 300 x 250			
<i>Kit of:</i>	<i>Anchor size</i> $\varnothing \times La$ (mm)	<i>Pcs. per box</i>	<i>Boxes</i>	<i>Total pcs.</i>
VS 31 10 080	10 x 80	50	3	150
VS 31 10 100	10 x 100	50	3	150
VS 31 10 120	10 x 120	50	3	150
VS 31 10 140	10 x 140	25	2	50
VS 31 10 160	10 x 160	25	2	50
VS 31 10 200	10 x 200	25	2	50
Total pcs.:				600

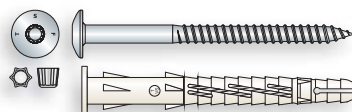
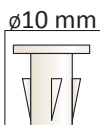

European Technical Approval
Use Category: a,b,c
ETA-13/0135 ETAG 020
DoP available on www.tecni.it/DoP

Item code	"ExpoBox" dimensions			
	B x b x h (mm)			
KIT VS 71 001	750 x 300 x 250			
<i>Kit of:</i>	<i>Anchor size</i> $\varnothing \times La$ (mm)	<i>Pcs. per box</i>	<i>Boxes</i>	<i>Total pcs.</i>
VS 71 10 080	10 x 80	50	3	150
VS 71 10 100	10 x 100	50	3	150
VS 71 10 120	10 x 120	50	3	150
VS 71 10 140	10 x 140	25	2	50
VS 71 10 160	10 x 160	25	2	50
VS 71 10 200	10 x 200	25	2	50
Total pcs.:				600

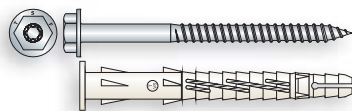
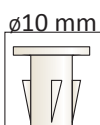

European Technical Approval
Use Category: a,b,c
ETA-13/0135 ETAG 020
DoP available on www.tecni.it/DoP

Item code	"ExpoBox" dimensions			
	B x b x h (mm)			
KIT VS 81 001	750 x 300 x 250			
<i>Kit of:</i>	<i>Anchor size</i> $\varnothing \times La$ (mm)	<i>Pcs. per box</i>	<i>Boxes</i>	<i>Total pcs.</i>
VS 81 10 080	10 x 80	50	3	150
VS 81 10 100	10 x 100	50	3	150
VS 81 10 120	10 x 120	50	3	150
VS 81 10 140	10 x 140	25	2	50
VS 81 10 160	10 x 160	25	2	50
VS 81 10 200	10 x 200	25	2	50
Total pcs.:				600

ExpoBox

Handyplug
 THE FACTORY PLUG

Kit VS-Handyplug®

"ExpoBox" display stand with 30 Boxes of VS-Handyplug® universal anchors - \varnothing 8 and 10mm with floor stand

KIT VS 00 002 \varnothing 8

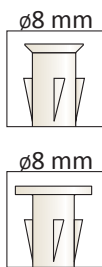

Item code	"ExpoBox" dimensions			
	B x b x h (mm)			
KIT VS 00 002	750 x 300 x 250			
Kit of:	Anchor size $\varnothing \times L$ (mm)	Pcs. per box	Boxes	Total pcs.
VS 11 - CSK EDGE nylon anchor with CSK head screw				
VS 11 08 080	8 x 80	100	2	200
VS 11 08 100	8 x 100	100	2	200
VS 11 08 120	8 x 120	100	1	100
VS 11 08 140	8 x 140	50	1	50
VS 21 - CSK EDGE nylon anchor with mushroom head screw				
VS 21 08 080	8 x 80	100	2	200
VS 21 08 100	8 x 100	100	2	200
VS 21 08 120	8 x 120	100	1	100
VS 21 08 140	8 x 140	50	1	50
VS 31 - CSK EDGE nylon anchor with HEX head screw				
VS 31 08 080	8 x 80	100	2	200
VS 31 08 100	8 x 100	100	2	200
VS 31 08 120	8 x 120	100	1	100
VS 31 08 140	8 x 140	50	1	50
VS 71 - CYLINDER EDGE nylon anchor with mushroom head screw				
VS 71 08 080	8 x 80	100	2	200
VS 71 08 100	8 x 100	100	2	200
VS 71 08 120	8 x 120	100	1	100
VS 71 08 140	8 x 140	50	1	50
VS 81 - CYLINDER EDGE nylon anchor with HEX head screw				
VS 81 08 080	8 x 80	100	2	200
VS 81 08 100	8 x 100	100	2	200
VS 81 08 120	8 x 120	100	1	100
VS 81 08 140	8 x 140	50	1	50
Total pcs.:				2.750



European Technical Approval
 Use Category: a,b,c
 ETA-13/0135 ETAG 020
 DoP available on www.tecni.it/DoP

KIT VS 00 001 \varnothing 10

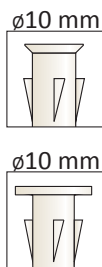

Item code	"ExpoBox" dimensions			
	B x b x h (mm)			
KIT VS 00 001	750 x 300 x 250			
Kit of:	Anchor size $\varnothing \times L$ (mm)	Pcs. per box	Boxes	Total pcs.
VS 11 - CSK EDGE nylon anchor with CSK head screw				
VS 11 10 100	10 x 100	50	2	100
VS 11 10 140	10 x 140	50	2	100
VS 11 10 200	10 x 200	50	2	100
VS 21 - CSK EDGE nylon anchor with mushroom head screw				
VS 21 10 100	10 x 100	50	2	100
VS 21 10 140	10 x 140	25	2	50
VS 21 10 200	10 x 200	25	2	50
VS 31 - CSK EDGE nylon anchor with HEX head screw				
VS 31 10 100	10 x 100	50	2	100
VS 31 10 140	10 x 140	25	2	50
VS 31 10 200	10 x 200	25	2	50
VS 71 - CYLINDER EDGE nylon anchor with mushroom head screw				
VS 71 10 100	10 x 100	50	2	100
VS 71 10 140	10 x 140	25	2	50
VS 71 10 200	10 x 200	25	2	50
VS 81 - CYLINDER EDGE nylon anchor with HEX head screw				
VS 81 10 100	10 x 100	50	2	100
VS 81 10 140	10 x 140	25	2	50
VS 81 10 200	10 x 200	25	2	50
Total pcs.:				1.100



European Technical Approval
 Use Category: a,b,c
 ETA-13/0135 ETAG 020
 DoP available on www.tecni.it/DoP

ExpoBox

Handyplug
IL TASSILLO TUTTOFARE



Kit VS-Handyplug®

“ExpoBox” display stand with 30 Boxes of VS-Handyplug® universal anchors - \varnothing 8 and 10mm with floor stand

\varnothing 8 and \varnothing 10 mm

\varnothing 8 mm



\varnothing 8 mm

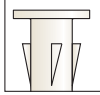

\varnothing 10 mm

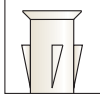

\varnothing 10 mm

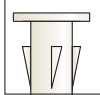

European Technical Approval
Use Category: a,b,c
ETA-13/0135 ETAG 020
DoP available on www.tecfi.it/DoP

Item code	“ExpoBox” dimensions			
	B x b x h (mm)			
KIT VS 00 003	750 x 300 x 250			
Kit of:	Anchor size \varnothing x La (mm)	Pcs. per box	Boxes	Total pcs.
VS 11 - CSK EDGE nylon anchor with CSK head screw				
VS 11 08 080	8 x 80	100	1	100
VS 11 08 120	8 x 120	100	1	100
VS 11 10 100	10 x 100	50	1	50
VS 11 10 120	10 x 120	50	1	50
VS 11 10 160	10 x 160	50	1	50
VS 11 10 200	10 x 200	50	1	50
VS 21 - CSK EDGE nylon anchor with mushroom head screw				
VS 21 08 080	8 x 80	100	1	100
VS 21 08 120	8 x 120	100	1	100
VS 21 10 100	10 x 100	50	1	50
VS 21 10 120	10 x 120	50	1	50
VS 21 10 160	10 x 160	25	1	25
VS 21 10 200	10 x 200	25	1	25
VS 31 - CSK EDGE nylon anchor with HEX head screw				
VS 31 08 080	8 x 80	100	1	100
VS 31 08 120	8 x 120	100	1	100
VS 31 10 100	10 x 100	50	1	50
VS 31 10 120	10 x 120	50	1	50
VS 31 10 160	10 x 160	25	1	25
VS 31 10 200	10 x 200	25	1	25
VS 71 - CYLINDER EDGE nylon anchor with mushroom head screw				
VS 71 08 080	8 x 80	100	1	100
VS 71 08 120	8 x 120	100	1	100
VS 71 10 100	10 x 100	50	1	50
VS 71 10 120	10 x 120	50	1	50
VS 71 10 160	10 x 160	25	1	25
VS 71 10 200	10 x 200	25	1	25
VS 81 - CYLINDER EDGE nylon anchor with HEX head screw				
VS 81 08 080	8 x 80	100	1	100
VS 81 08 120	8 x 120	100	1	100
VS 81 10 100	10 x 100	50	1	50
VS 81 10 120	10 x 120	50	1	50
VS 81 10 160	10 x 160	25	1	25
VS 81 10 200	10 x 200	25	1	25
Total pcs.:				1.800

TOT

“ExpoBox” floor stand



Item Code	Size L x l x h (mm)	Pcs. per box
TOT 01 07 001*	760 x 300 x 800	1

- * For every two Kits purchased, one stand free
- * gratuit avec l'achat de 2 KIT (avec le présentoir "Expobox")
- * Kostenlos bei Erwerb 2 KIT (mit "Expobox" Verkaufsständer)
- * de regalo con la compra de 2 Kit (completos de expositores "ExpoBox")
- * Бесплатно при покупке 2х комплектов (с настольным дисплеем "ExpoBox")

SFL h 234 cm

Metallic wall stand - Fire Red (RAL 3000) and Metallic Grey painted



Item code	Size	Pcs.
	L x h x P (cm)	
SFL 02 05 234	100 x 234 x 60	1
SFL 01 05 234	100 x 234 x 60	1
SFL 01 01 234	100 x 234 x 60	1



SFL 02 05 234



SFL 01 05 234



SFL 01 01 234

SFF h 234 cm

Metallic wall stand with perforated panel - Fire Red (RAL 3000) and Metallic Grey painted



Item code	Size	Pcs.
	L x h x P (cm)	
SFF 02 02 234	100 x 234 x 60	1
SFF 01 02 234	100 x 234 x 60	1
SFF 01 01 234	100 x 234 x 60	1

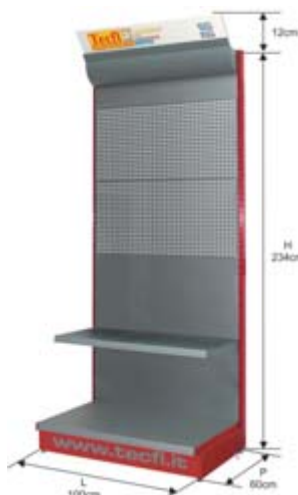

SFF 02 02 234



SFF 01 02 234



SFF 01 01 234

SFL h 158 cm

Metallic wall stand - Fire Red (RAL 3000) and Metallic Grey painted

Item code	Size	Pcs.
	L x h x P (cm)	
SFL 02 04 158	100 x 158 x 60	1
SFL 01 04 158	100 x 158 x 60	1
SFL 01 01 158	100 x 158 x 60	1



SFL 02 04 158



SFL 01 04 158



SFL 01 01 158

GND h 158 cm

Metallic "gondola" stand - Fire Red (RAL 3000) and Metallic Grey painted

Item code	Size	Pcs.
	L x h x P (cm)	
GND 02 08 140	100 x 140 x 128	1
GND 01 08 140	100 x 140 x 128	1
GND 01 02 140	100 x 140 x 128	1

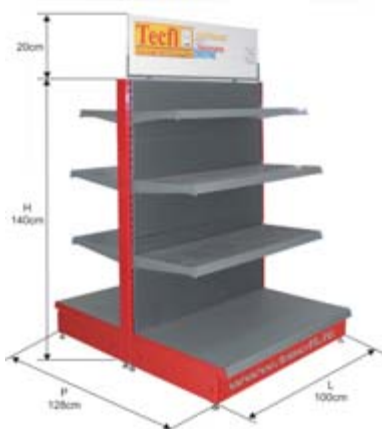

GND 02 08 140



GND 01 08 140



GND 01 02 140

PNT

Metallic uprights - Fire Red (RAL 3000) painted

Item code	Size	Pcs.
	P x h (cm)	
PNT 01 00 234	60 x 234	1
PNT 01 00 158	60 x 158	1
PNT 02 00 140	128 x 140	1

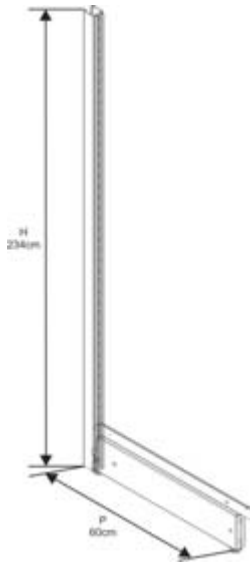

PNT 01 00 234
Uprights for wall stand
h 234 cm

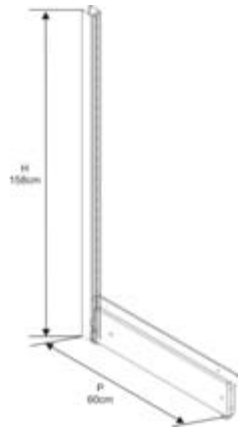

PNT 01 00 158
Uprights for wall stand
h 158 cm

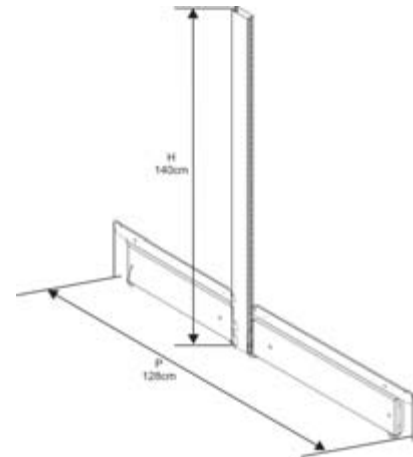

PNT 02 00 140
Uprights for "gondola" stand
h 140 cm

RPN

Metallic shelves - Metallic Grey painted

Item code	Size	Pcs.
	L x P (cm)	
RPN 01 30 100	100 x 30	1
RPN 01 40 100	100 x 40	1

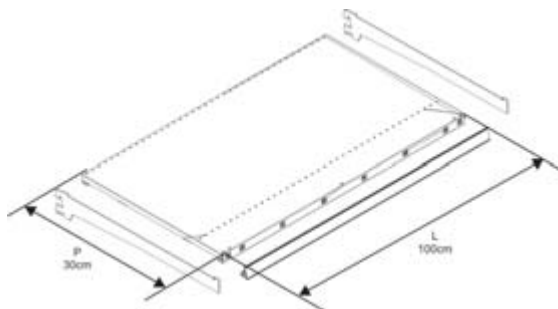

RPN 01 30 100
30 x 100 cm

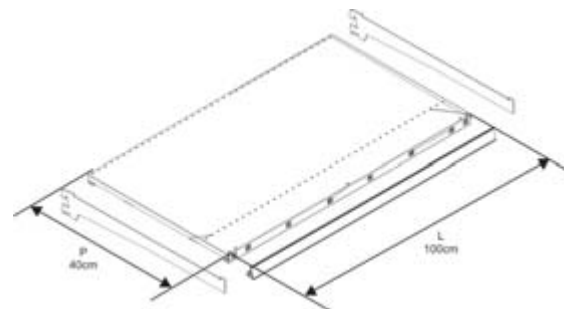

RPN 01 40 100
40 x 100 cm

PAN

Metallic back panels - Metallic Grey painted

Item code	Size	Pcs.
	L x H (cm)	
PAN 00 47 100	100 x 47	1
PAN 01 47 100	100 x 47	1

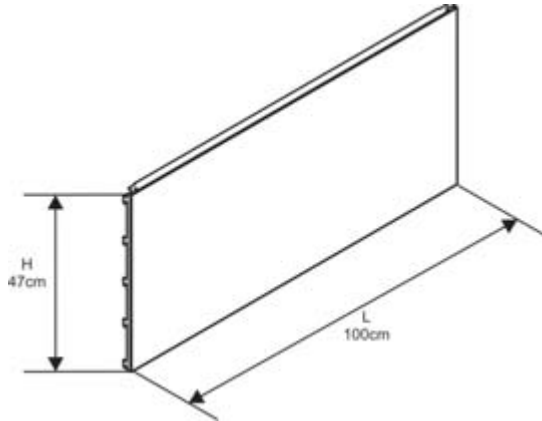

PAN 00 47 100
Back panel

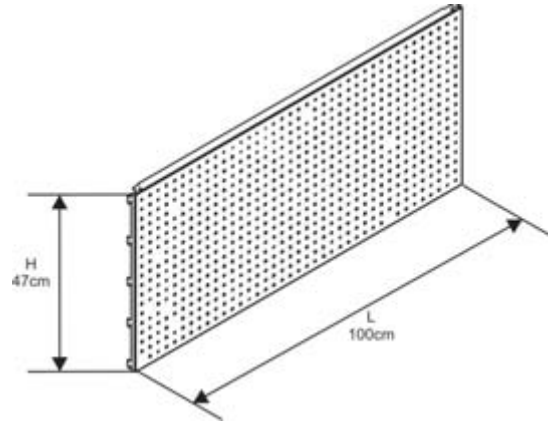

PAN 01 47 100
Perforated back panel

GNC

Hooks for perforated panels

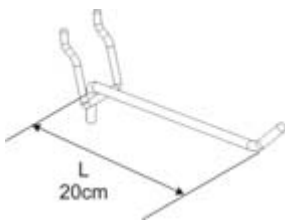

GNC 01 00 020
Single Hook
length 20 cm

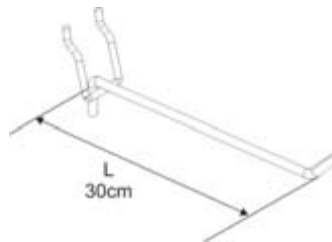

GNC 01 00 030
Single Hook
length 30 cm

Item code	Size	Pcs.
	L (cm)	
GNC 01 00 020	20	1
GNC 01 00 030	30	1
GNC 03 00 020	20	1
GNC 02 28 017	17	1
GNC 02 25 030	30	1

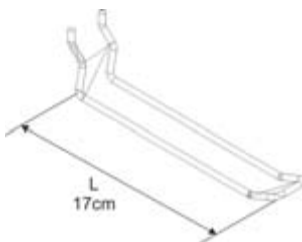

GNC 02 28 017
Double hook
length 17 cm

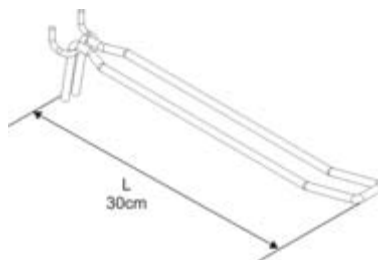

GNC 02 25 030
Special double hook
length 30 cm

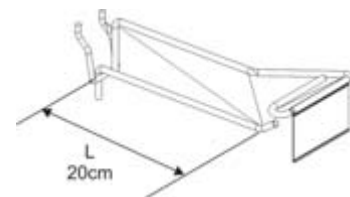

GNC 03 00 020
Single hook with price holder
length 17 cm

EXP

General wall display stand

EXP General wall display stand



Item code	Items on display	Size
		L x h (cm)
EXP 01 01 000	with main Tecfi products	100 x 150

EXP Wall display stand, 70 x 100 cm



Item code	Items on display	Size
		L x h (cm)
70 x 100 cm		
EXP 01 10 002	Roofing fixing systems	70 x 100
EXP 01 23 002	ETA-CE certified anchors	70 x 100
EXP 01 24 002	Woodpecker® - Wood beam connectors	70 x 100
EXP 01 22 002	Woodpecker® - Wood line	70 x 100
EXP 01 25 002	Fixing systems for renewable energy plants	70 x 100
EXP 01 26 002	VS-Handyplug® - Multi-purpose nylon anchors	70 x 100
EXP 01 27 002	Sealants, Adhesives and Foams	70 x 100

EXP Wall display stand, 30 x 46 cm



Item code	Items on display	Size
		L x h (cm)
30 x 46 cm		
EXP 01 10 003	Roofing fixing systems	30 x 46
EXP 01 23 003	ETA-CE certified anchors	30 x 46
EXP 01 22 003	Woodpecker® - Wood line	30 x 46
EXP 01 25 003	Fixing systems for renewable energy plants	30 x 46
EXP 01 26 003	VS-Handyplug® - Multi-purpose nylon anchors	30 x 46
EXP 01 27 003	Sealants, Adhesives and Foams	30 x 46

BRO

Brochures

The Italian Job ETA-CE certified anchors



Item code	Items
BRO 01 17 000	HXE-CONCRETO® - Concrete screws, ETA-CE option 1
BRO 01 08 000	HVE-ROCK® - High performance anchors, EETA-CE option 1
BRO 01 16 000	AJE - Wedge anchors, ETA-CE option 1
BRO 01 20 000	ZJE - Wedge anchors, ETA-CE option 7
BRO 01 12 000	DSE - Sleeve anchors, ETA-CE option 7
BRO 01 13 000	DXE - Sleeve anchors with unlosable nut, ETA-CE option 7
BRO 01 18 000	ETA-CE certified anchors

Handyplug® Multi-purpose nylon anchors, ETA-CE certified



Item code	Items
BRO 01 15 000	VS-Handyplug® - Multi-purpose nylon anchors

Woodpecker® Wood Line



Item code	Items
BRO 01 02 000	Woodpecker® - Chipboard screws
BRO 01 03 000	Woodpecker® - TT series chipboard screws
BRO 01 10 000	Woodpecker® - Wood beam connectors

NW - HXB Fixing systems for renewable energy plants



Item code	Items
BRO 01 19 000	Fixing systems for renewable energy plants



General Sales conditions

1. Orders

1.1 The order is understood to be accepted only by virtue of the seller's written confirmation. Up until that moment, offers and quotations formulated by the seller or by its agents, representatives or helpers are not binding for the seller.

1.2 Any general conditions of the buyer will not be applicable, partially or otherwise, if not expressly accepted in writing by the seller.

2. Prices and Payments

2.1 The price of the products is always understood including of packaging, but to be net of transport costs. If Insurance is requested, it would be charged separately.

2.2 The price of the products, and also any other amount due to the seller for any reason, is understood to be net at the domicile of the seller.

2.3 In the event of breach of the terms and conditions of payment, or financial difficulties of the buyer that have occurred after the signature of the contract, the seller is exonerated from any delivery obligation, even relating to products other than those to which said in observance refers. In such cases, the buyer forfeits the benefit of the term and consequently the seller has the faculty to demand immediate payment of the whole amount due, without prejudice to its right to withdraw from the contract, holding back the amounts paid by the buyer up to that point by way of partial advance settlement of the damages and with due reserve to additional damages.

2.4 The buyer may not enforce any non-fulfilments of the seller, nor enforce the guarantees indicated in Article 3 below, if it is not up-to-date with the payments; any non-fulfilments of the seller will not permit the buyer to suspend or delay payments.

2.5 Delays in payments with respect to the dates established will involve the automatic charging of interest, without the need for any request, at the official discount rate in force in the country of the seller, as well as the exclusion of the guarantee pursuant to Article 3 until settlement of the payments outstanding.

2.6 All banking charges except those of the Italian bank, must be on the buyer's account.

3. Commodity Inspection, Warranty

3.1 The seller is not responsible for the compliancy defects of the products and faults caused by the failure to observe the instructions anticipated in the instruction manual or in the technical data sheet (if available in our small box or into our official catalogue; otherwise it can be requested to our Technical Dept.). Neither will the seller be responsible for compliancy defects or faults which depend on erroneous use of the products by the buyer or if the latter has made changes or repairs without the prior written consent of the seller or, in any event, for those defects due to causes which arise after the transfer of the risk has taken place.

The buyer, on penalty of forfeiture, must report the compliancy defect or the fault of the products to the seller, specifying in detail and in writing their nature, within 8 days of receiving of goods.

3.2 The seller, after having ascertained the existence of the defect, must carry out the replacements with shipment.

3.3 Any compensation for any damages to the buyer may not, in any event, exceed the portion of value of the faulty part.

4. Delivery

4.1 The products shall be delivered Incoterms® 2010 – ExWorks Seller, according to the delivery schedule provided in the purchase orders.

4.2 The delivery terms are understood to be approximate in favour of the seller and in any event involving an adequate margin of tolerance.

4.3 In the event of split deliveries, in no event may the delay or failure to carry out one or more deliveries lead to the right of the buyer to terminate the contract in relation to the deliveries already made or future ones.

4.4 The delivery date will be extended for a period equal to that of the duration of the impediment, on occurrence of causes not dependent on the will of the seller and the buyer, such as strikes of any kind, fires, floods, power cuts, lack or scarcity of raw materials, malfunctions and accidents at the production plants of the seller, delays in granting authorizations of the authorities and other impediments independent from the will of the parties which temporarily render the delivery impossible or excessively onerous.

5. Transfer risks

5.1 Whatever the transport and return/shipment methods specified in the particular conditions of the contract are, the products travel at the risk of the buyer, even in the event of return carriage paid (CPT), or any other equivalent or similar clause, relevant for the sole purpose of disciplining the breakdown of the transport costs. The products are not insured by the seller unless written request is made by the buyer who, in that event, undertakes the related expense involved.

6. Ownership

6.1 Ownership of the products is transferred at the time of delivery to the buyer, if at that time the price has been paid in full.

6.2 In the event of sales paid by instalment, the buyer acquires ownership of the products delivered on payment of the last instalment of the price, but undertakes the risks from the time of delivery. In this case, the buyer remains the depositary of the products and the materials belonging to the seller until the moment the purchase price is paid in full.

7. Legal venue

7.1 The Local Court (Italy) in Naples, according to the Italian Law.